

M12 C code male moldable connector, unshielded/M12, C型公头成型式连接器, 不带屏蔽

Illustration/尺寸

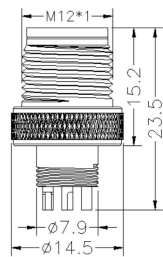

Product photo/产品图



Part number/产品料号

Pins/针数	Code/型	Part number/产品料号
2pins/2针	C code/C型	12C278
3pins/3针	C code/C型	12C271
4pins/4针	C code/C型	12C280
5pins/5针	C code/C型	12C401
6pins/6针	C code/C型	12C403

Pin assignment front view/针位分布前视图

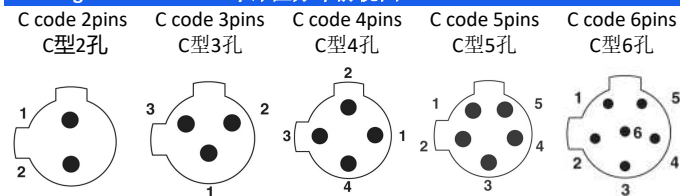

General data/常规数据

Pin Numbers/针数	2pins/2针	3pins/3针	4pins/4针	5pins/5针	6pins/6针
Rated voltage/额定电压	250V			60V	30V
Rated current(40°C)/额定电流	4A				
Standards/标准	IEC 61076-2-101				
Termination/焊接方式	solder/焊接				
Degree of protection/防护等级	IP67, IP68, IP69K				
Wire gauge(mm²)/线规(平方数)	0.14mm²-0.75mm²				
Wire gauge(AWG)/线号(平方数)	26AWG-18AWG				
Mechanical operation/插拔次数	>100 mating cycles/大于100次				
Ambient temperature (operation)/操作温度	-25°C~+85°C				
Contact resistance/接触电阻	≤5mΩ				
Insulation resistance/绝缘电阻	≥100MΩ				
Connector body/胶芯	TPU				
Pins/端子	Brass with gold plated/黄铜镀金				
Screw/螺丝	Brass with nickel plated/黄铜镀镍				
Environmental compliance/环境符合标准	RoHS, Reach				

M12 C code female moldable connector, unshielded/M12,C型母头成型式连接器, 不带屏蔽

Illustration/尺寸

Product photo/产品图

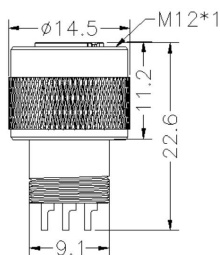

Part number/产品料号

Pins/针数	Code/型	Part number/产品料号
2pins/2针	C code/C型	12C279
3pins/3针	C code/C型	12C272
4pins/4针	C code/C型	12C281
5pins/5针	C code/C型	12C402
6pins/6针	C code/C型	12C404

Pin assignment front view/针位分布前视图

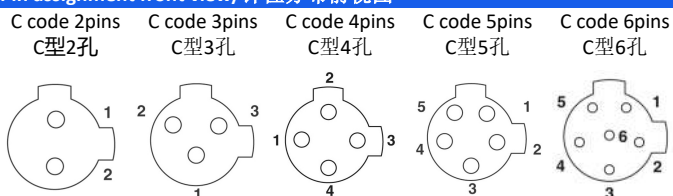

General data/常规数据

Pin Numbers/针数	2pins/2针	3pins/3针	4pins/4针	5pins/5针	6pins/6针
Rated voltage/额定电压	250V			60V	30V
Rated current(40°C)/额定电流	4A				2A
Standards/标准	IEC 61076-2-101				
Termination/焊接方式	solder/焊接				
Degree of protection/防护等级	IP67, IP68, IP69K				
Wire gauge(mm²)/线规(平方数)	0.14mm²-0.75mm²				
Wire gauge(AWG)/线号(平方数)	26AWG-18AWG				
Mechanical operation/插拔次数	>100 mating cycles/大于100次				
Ambient temperature (operation)/操作温度	-25°C~+85°C				
Contact resistance/接触电阻	≤5mΩ				
Insulation resistance/绝缘电阻	≥100MΩ				
Connector body/胶芯	TPU				
Pins/端子	Phosphorus copper with gold plated/磷铜镀金				
Screw/螺丝	Brass with nickel plated/黄铜镀镍				
Environmental compliance/环境符合标准	RoHS, Reach				

M12 C code male moldable connector with shielded/M12, C型公头成型式连接器, 带屏蔽

Illustration/尺寸

Product photo/产品图

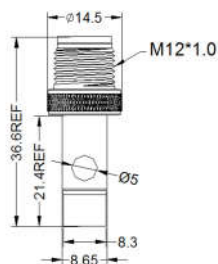

Part number/产品料号

Pins/针数	Code/型	Part number/产品料号
2pins/2针	C code/C型	12C282
3pins/3针	C code/C型	12C284
4pins/4针	C code/C型	12C286
5pins/5针	C code/C型	12C405
6pins/6针	C code/C型	12C407

Pin assignment front view/针位分布前视图

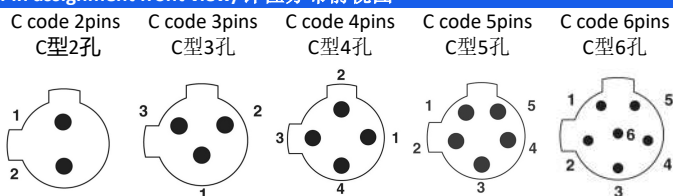

General data/常规数据

Pin Numbers/针数	2pins/2针	3pins/3针	4pins/4针	5pins/5针	6pins/6针
Rated voltage/额定电压	250V			60V	30V
Rated current(40°C)/额定电流	4A				
Standards/标准	IEC 61076-2-101				
Termination/焊接方式	solder/焊接				
Degree of protection/防护等级	IP67, IP68, IP69K				
Wire gauge(mm²)/线规(平方数)	0.14mm²-0.75mm²				
Wire gauge(AWG)/线号(平方数)	26AWG-18AWG				
Mechanical operation/插拔次数	>100 mating cycles/大于100次				
Ambient temperature (operation)/操作温度	-25°C~+85°C				
Contact resistance/接触电阻	≤5mΩ				
Insulation resistance/绝缘电阻	≥100MΩ				
Connector body/胶芯	TPU				
Pins/端子	Brass with gold plated/黄铜镀金				
Screw/螺丝	Brass with nickel plated/黄铜镀镍				
Environmental compliance/环境符合标准	RoHs, Reach				

M12 C code female moldable connector with shielded/M12, C型母头成型式连接器, 带屏蔽

Illustration/尺寸

Product photo/产品图

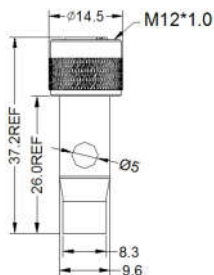

Part number/产品料号

Pins/针数	Code/型	Part number/产品料号
2pins/2针	C code/C型	12C283
3pins/3针	C code/C型	12C285
4pins/4针	C code/C型	12C287
5pins/5针	C code/C型	12C406
6pins/6针	C code/C型	12C408

Pin assignment front view/针位分布前视图

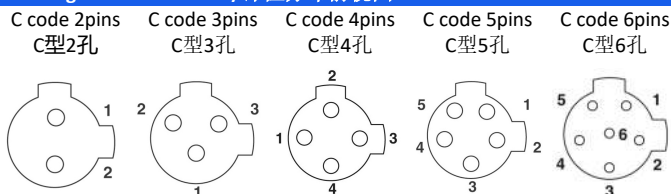

General data/常规数据

Pin Numbers/针数	2pins/2针	3pins/3针	4pins/4针	5pins/5针	6pins/6针
Rated voltage/额定电压	250V			60V	30V
Rated current(40°C)/额定电流	4A				2A
Standards/标准	IEC 61076-2-101				
Termination/焊接方式	solder/焊接				
Degree of protection/防护等级	IP67, IP68, IP69K				
Wire gauge(mm²)/线规(平方数)	0.14mm²-0.75mm²				
Wire gauge(AWG)/线号(平方数)	26AWG-18AWG				
Mechanical operation/插拔次数	>100 mating cycles/大于100次				
Ambient temperature (operation)/操作温度	-25°C~+85°C				
Contact resistance/接触电阻	≤5mΩ				
Insulation resistance/绝缘电阻	≥100MΩ				
Connector body/胶芯	TPU				
Pins/端子	Phosphorus copper with gold plated/磷铜镀金				
Screw/螺丝	Brass with nickel plated/黄铜镀镍				
Environmental compliance/环境符合标准	RoHS, Reach				

M12 C code male straight front panel mount connector, unshielded, insert/M12, C型公头直头前锁面板板端, 不带屏蔽

Illustration/尺寸

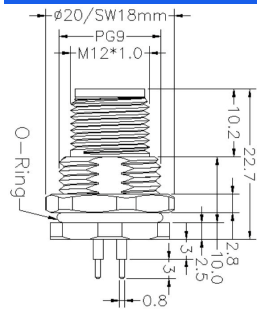

Product photo/产品图



Part number/产品料号

Pins/针数	Code/型	Part number/产品料号
		PG9 thread 15.3±0.1/PG9螺纹15.3±0.1
2pins/2针	C code/C型	12B268
3pins/3针	C code/C型	12B243
4pins/4针	C code/C型	12B263
5pins/5针	C code/C型	12B335
6pins/6针	C code/C型	12B339

Pin assignment front view/针位分布前视图

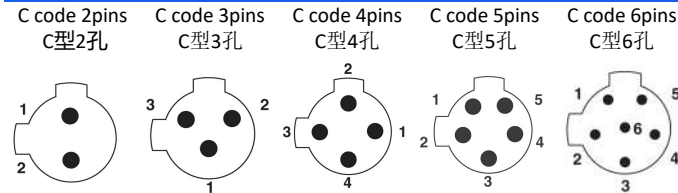

General data/常规数据

Pin Numbers/针数	2pins/2针	3pins/3针	4pins/4针	5pins/5针	6pins/6针
Rated voltage/额定电压	250V			60V	30V
Rated current(40°C)/额定电流	4A				2A
Standards/标准	IEC 61076-2-101				
Termination/焊接方式	solder/焊接				
Degree of protection/防护等级	IP67, IP68, IP69K				
Wire gauge(mm²)/线规(平方数)	0.14mm²-0.75mm²				
Wire gauge(AWG)/线号(平方数)	26AWG-18AWG				
Mechanical operation/插拔次数	>100 mating cycles/大于100次				
Ambient temperature (operation)/操作温度	-25°C~+85°C				
Contact resistance/接触电阻	≤5mΩ				
Insulation resistance/绝缘电阻	≥100MΩ				
Connector body/胶芯	TPU				
Pins/端子	Brass with gold plated/黄铜镀金				
Screw/螺丝	Brass with nickel plated/黄铜镀镍				
Environmental compliance/环境符合标准	RoHs, Reach				

M12 C code female straight front panel mount connector, unshielded, insert/M12, C型母头直头前锁面板板端, 不带屏蔽

Illustration/尺寸

Product photo/产品图

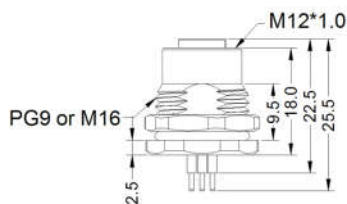

Part number/产品料号

Pins/针数	Code/型	Part number/产品料号
		PG9 thread 15.3±0.1/PG9螺纹15.3±0.1
2pins/2针	C code/C型	12B270
3pins/3针	C code/C型	12B264
4pins/4针	C code/C型	12B266
5pins/5针	C code/C型	12B337
6pins/6针	C code/C型	12B341

Pin assignment front view/针位分布前视图

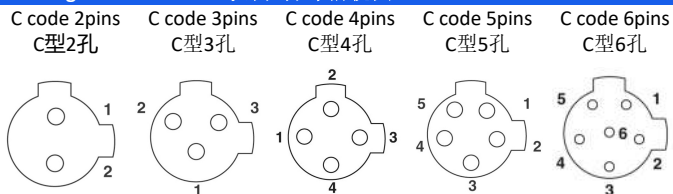

General data/常规数据

Pin Numbers/针数	2pins/2针	3pins/3针	4pins/4针	5pins/5针	6pins/6针
Rated voltage/额定电压	250V			60V	30V
Rated current(40°C)/额定电流	4A				2A
Standards/标准	IEC 61076-2-101				
Termination/焊接方式	solder/焊接				
Degree of protection/防护等级	IP67, IP68, IP69K				
Wire gauge(mm²)/线规(平方数)	0.14mm²-0.75mm²				
Wire gauge(AWG)/线号(平方数)	26AWG-18AWG				
Mechanical operation/插拔次数	>100 mating cycles/大于100次				
Ambient temperature (operation)/操作温度	-25°C~+85°C				
Contact resistance/接触电阻	≤5mΩ				
Insulation resistance/绝缘电阻	≥100MΩ				
Connector body/胶芯	TPU				
Pins/端子	Phosphorus copper with gold plated/磷铜镀金				
Screw/螺丝	Brass with nickel plated/黄铜镀镍				
Environmental compliance/环境符合标准	RoHs, Reach				

M12 C code male straight rear panel mount connector, unshielded, insert/M12, C型公头直头后锁面板板端, 不带屏蔽

Illustration/尺寸

Product photo/产品图

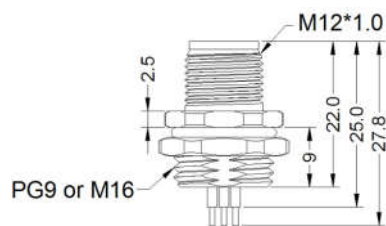

Part number/产品料号

Pins/针数	Code/型	Part number/产品料号
		PG9 thread 15.3±0.1/PG9螺纹15.3±0.1
2pins/2针	C code/C型	12B269
3pins/3针	C code/C型	12B244
4pins/4针	C code/C型	12B163
5pins/5针	C code/C型	12B336
6pins/6针	C code/C型	12B340

Pin assignment front view/针位分布前视图

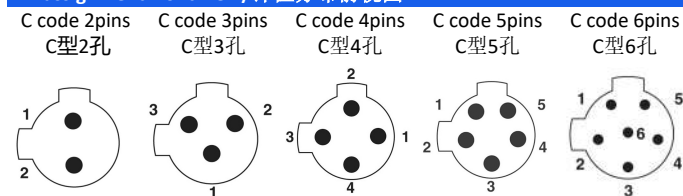

General data/常规数据

Pin Numbers/针数	2pins/2针	3pins/3针	4pins/4针	5pins/5针	6pins/6针
Rated voltage/额定电压	250V			60V	30V
Rated current(40°C)/额定电流	4A				2A
Standards/标准	IEC 61076-2-101				
Termination/焊接方式	solder/焊接				
Degree of protection/防护等级	IP67, IP68, IP69K				
Wire gauge(mm²)/线规(平方数)	0.14mm²-0.75mm²				
Wire gauge(AWG)/线号(平方数)	26AWG-18AWG				
Mechanical operation/插拔次数	>100 mating cycles/大于100次				
Ambient temperature (operation)/操作温度	-25°C~+85°C				
Contact resistance/接触电阻	≤5mΩ				
Insulation resistance/绝缘电阻	≥100MΩ				
Connector body/胶芯	TPU				
Pins/端子	Brass with gold plated/黄铜镀金				
Screw/螺丝	Brass with nickel plated/黄铜镀镍				
Environmental compliance/环境符合标准	RoHS, Reach				

M12 C code female straight rear panel mount connector, unshielded, insert/M12, C型母头直头后锁面板板端, 不带屏蔽

Illustration/尺寸

Product photo/产品图

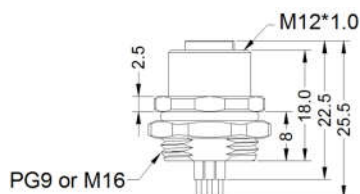

Part number/产品料号

Pins/针数	Code/型	Part number/产品料号
		PG9 thread 15.3±0.1/PG9螺纹15.3±0.1
2pins/2针	C code/C型	12B271
3pins/3针	C code/C型	12B265
4pins/4针	C code/C型	12B267
5pins/5针	C code/C型	12B338
6pins/6针	C code/C型	12B342

Pin assignment front view/针位分布前视图

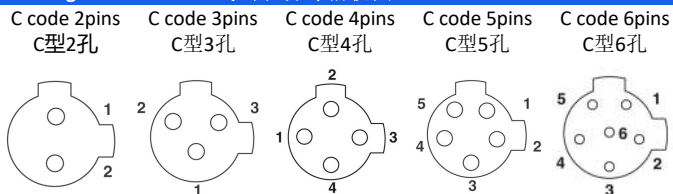

General data/常规数据

Pin Numbers/针数	2pins/2针	3pins/3针	4pins/4针	5pins/5针	6pins/6针
Rated voltage/额定电压	250V			60V	30V
Rated current(40°C)/额定电流	4A				2A
Standards/标准	IEC 61076-2-101				
Termination/焊接方式	solder/焊接				
Degree of protection/防护等级	IP67, IP68, IP69K				
Wire gauge(mm²)/线规(平方数)	0.14mm²-0.75mm²				
Wire gauge(AWG)/线号(平方数)	26AWG-18AWG				
Mechanical operation/插拔次数	>100 mating cycles/大于100次				
Ambient temperature (operation)/操作温度	-25°C~+85°C				
Contact resistance/接触电阻	≤5mΩ				
Insulation resistance/绝缘电阻	≥100MΩ				
Connector body/胶芯	TPU				
Pins/端子	Phosphorus copper with gold plated/磷铜镀金				
Screw/螺丝	Brass with nickel plated/黄铜镀镍				
Environmental compliance/环境符合标准	RoHs, Reach				

M12 5pins C code male straight front panel mount connector, unshielded, solder/M12,5针,C型公头直头前锁面板焊线式,不带屏蔽

Illustration/尺寸

Product photo/产品图

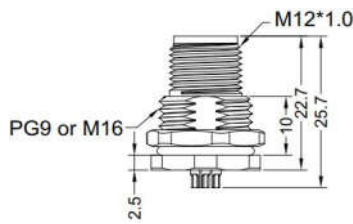

Part number/产品料号

Pins/针数	Code/型	Part number/产品料号	
		PG9 thread 15.3±0.1/PG9螺纹15.3±0.1	M16 thread 16±0.1/M16螺纹16±0.1
2pins/2针	C code/C型	12H109	12H111
3pins/3针	C code/C型	12H113	12H115
4pins/4针	C code/C型	12H117	12H119
5pins/5针	C code/C型	12H158	12H160
6pins/6针	C code/C型	12H162	12H164

Pin assignment front view/针位分布前视图

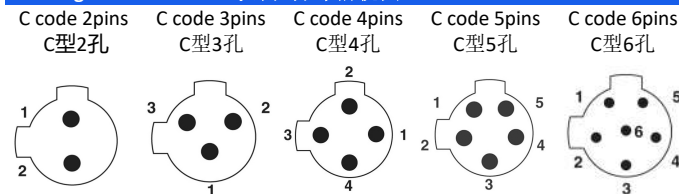

General data/常规数据

Pin Numbers/针数	2pins/2针	3pins/3针	4pins/4针	5pins/5针	6pins/6针
Rated voltage/额定电压	250V			60V	30V
Rated current(40°C)/额定电流	4A				2A
Standards/标准	IEC 61076-2-101				
Termination/焊接方式	solder/焊接				
Degree of protection/防护等级	IP67, IP68, IP69K				
Wire gauge(mm²)/线规(平方数)	0.14mm²-0.75mm²				
Wire gauge(AWG)/线号(平方数)	26AWG-18AWG				
Mechanical operation/插拔次数	>100 mating cycles/大于100次				
Ambient temperature (operation)/操作温度	-25°C~+85°C				
Contact resistance/接触电阻	≤5mΩ				
Insulation resistance/绝缘电阻	≥100MΩ				
Connector body/胶芯	TPU				
Pins/端子	Brass with gold plated/黄铜镀金				
Screw/螺丝	Brass with nickel plated/黄铜镀镍				
Environmental compliance/环境符合标准	RoHs, Reach				

M12 5pins C code male straight front panel mount connector, unshielded, solder/M12,5针,C型母头直头前锁面板焊线式,不带屏蔽

Illustration/尺寸

Product photo/产品图

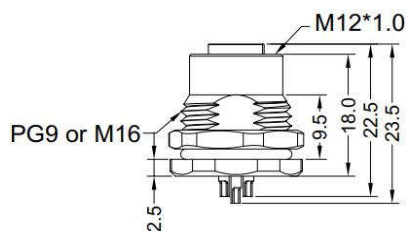

Part number/产品料号

Pins/针数	Code/型	Part number/产品料号	
		PG9 thread 15.3±0.1/PG9螺纹15.3±0.1	M16 thread 16±0.1/M16螺纹16±0.1
2pins/2针	C code/C型	12H166	12H168
3pins/3针	C code/C型	12H170	12H172
4pins/4针	C code/C型	12H174	12H176
5pins/5针	C code/C型	12H178	12H180
6pins/6针	C code/C型	12H182	12H184

Pin assignment front view/针位分布前视图

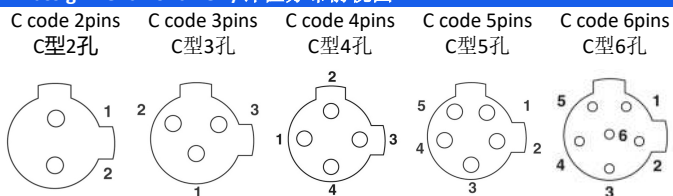

General data/常规数据

Pin Numbers/针数	2pins/2针	3pins/3针	4pins/4针	5pins/5针	6pins/6针
Rated voltage/额定电压	250V			60V	30V
Rated current(40°C)/额定电流	4A				2A
Standards/标准	IEC 61076-2-101				
Termination/焊接方式	solder/焊接				
Degree of protection/防护等级	IP67, IP68, IP69K				
Wire gauge(mm²)/线规(平方数)	0.14mm²-0.75mm²				
Wire gauge(AWG)/线号(平方数)	26AWG-18AWG				
Mechanical operation/插拔次数	>100 mating cycles/大于100次				
Ambient temperature (operation)/操作温度	-25°C~+85°C				
Contact resistance/接触电阻	≤5mΩ				
Insulation resistance/绝缘电阻	≥100MΩ				
Connector body/胶芯	TPU				
Pins/端子	Phosphorus copper with gold plated/磷铜镀金				
Screw/螺丝	Brass with nickel plated/黄铜镀镍				
Environmental compliance/环境符合标准	RoHs, Reach				

M12 5pins C code male straight rear panel mount connector , unshielded, solder/M12,5针,C型公头直头后锁面板焊线式,不带屏蔽

Illustration/尺寸

Product photo/产品图

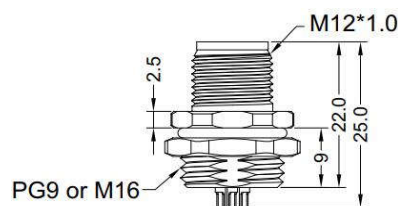

Part number/产品料号

Pins/针数	Code/型	Part number/产品料号	
		PG9 thread 15.3±0.1/PG9螺纹15.3±0.1	M16 thread 16±0.1/M16螺纹16±0.1
2pins/2针	C code/C型	12H110	12H112
3pins/3针	C code/C型	12H114	12H116
4pins/4针	C code/C型	12H118	12H120
5pins/5针	C code/C型	12H159	12H161
6pins/6针	C code/C型	12H163	12H165

Pin assignment front view/针位分布前视图

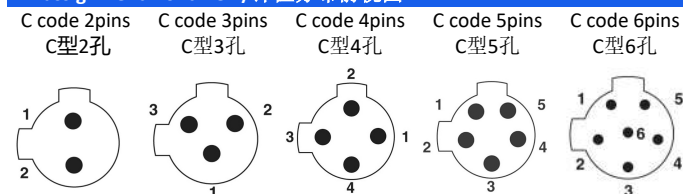

General data/常规数据

Pin Numbers/针数	2pins/2针	3pins/3针	4pins/4针	5pins/5针	6pins/6针
Rated voltage/额定电压	250V			60V	30V
Rated current(40°C)/额定电流	4A				2A
Standards/标准	IEC 61076-2-101				
Termination/焊接方式	solder/焊接				
Degree of protection/防护等级	IP67, IP68, IP69K				
Wire gauge(mm²)/线规(平方数)	0.14mm²-0.75mm²				
Wire gauge(AWG)/线号(平方数)	26AWG-18AWG				
Mechanical operation/插拔次数	>100 mating cycles/大于100次				
Ambient temperature (operation)/操作温度	-25°C~+85°C				
Contact resistance/接触电阻	≤5mΩ				
Insulation resistance/绝缘电阻	≥100MΩ				
Connector body/胶芯	TPU				
Pins/端子	Brass with gold plated/黄铜镀金				
Screw/螺丝	Brass with nickel plated/黄铜镀镍				
Environmental compliance/环境符合标准	RoHs, Reach				

M12 5pins C code female straight rear panel mount connector, unshielded, solder/M12,5针,C型母头直头后锁面板焊线式,不带屏蔽

Illustration/尺寸

Product photo/产品图

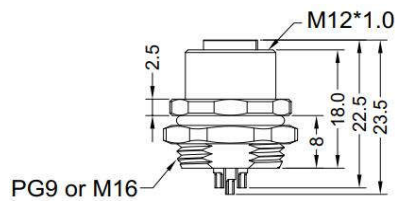

Part number/产品料号

Pins/针数	Code/型	Part number/产品料号	
		PG9 thread 15.3±0.1/PG9螺纹15.3±0.1	M16 thread 16±0.1/M16螺纹16±0.1
2pins/2针	C code/C型	12H167	12H169
3pins/3针	C code/C型	12H171	12H173
4pins/4针	C code/C型	12H175	12H177
5pins/5针	C code/C型	12H179	12H181
6pins/6针	C code/C型	12H183	12H185

Pin assignment front view/针位分布前视图

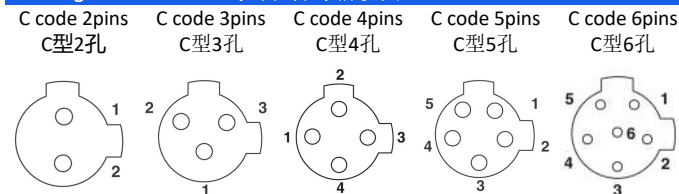

General data/常规数据

Pin Numbers/针数	2pins/2针	3pins/3针	4pins/4针	5pins/5针	6pins/6针
Rated voltage/额定电压	250V			60V	30V
Rated current(40°C)/额定电流	4A				2A
Standards/标准	IEC 61076-2-101				
Termination/焊接方式	solder/焊接				
Degree of protection/防护等级	IP67, IP68, IP69K				
Wire gauge(mm²)/线规(平方数)	0.14mm²-0.75mm²				
Wire gauge(AWG)/线号(平方数)	26AWG-18AWG				
Mechanical operation/插拔次数	>100 mating cycles/大于100次				
Ambient temperature (operation)/操作温度	-25°C~+85°C				
Contact resistance/接触电阻	≤5mΩ				
Insulation resistance/绝缘电阻	≥100MΩ				
Connector body/胶芯	TPU				
Pins/端子	Phosphorus copper with gold plated/磷铜镀金				
Screw/螺丝	Brass with nickel plated/黄铜镀镍				
Environmental compliance/环境符合标准	RoHs, Reach				

M12 C code male straight front panel mount connector, unshielded, single wires/M12, C型公头直头前锁面板带线, 不带屏蔽

Illustration/尺寸

Product photo/产品图

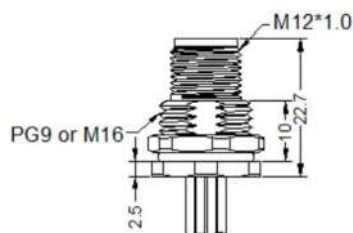

Part number/产品料号

Pins/针数	Code/型	Part number("X" is length millimetre mm)/产品料号("X"表示长度, 单位毫米mm)
		PG9 thread 15.3±0.1/PG9螺纹15.3±0.1
2pins/2针	C code/C型	12D329-X
3pins/3针	C code/C型	12D333-X
4pins/4针	C code/C型	12D337-X
5pins/5针	C code/C型	12D443-X
6pins/6针	C code/C型	12D445-X

Pin assignment front view/针位分布前视图

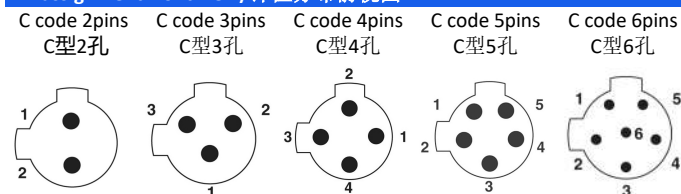

General data/常规数据

Pin Numbers/针数	2pins/2针	3pins/3针	4pins/4针	5pins/5针	6pins/6针
Rated voltage/额定电压	250V			60V	30V
Rated current(40°C)/额定电流	4A				2A
Standards/标准	IEC 61076-2-101				
Termination/焊接方式	solder/焊接				
Degree of protection/防护等级	IP67, IP68, IP69K				
Wire gauge(mm²)/线规(平方数)	0.14mm²-0.75mm²				
Wire gauge(AWG)/线号(平方数)	26AWG-18AWG				
Mechanical operation/插拔次数	>100 mating cycles/大于100次				
Ambient temperature (operation)/操作温度	-25°C~+85°C				
Contact resistance/接触电阻	≤5mΩ				
Insulation resistance/绝缘电阻	≥100MΩ				
Connector body/胶芯	TPU				
Pins/端子	Brass with gold plated/黄铜镀金				
Screw/螺丝	Brass with nickel plated/黄铜镀镍				
Environmental compliance/环境符合标准	RoHs, Reach				

M12 C code female straight front panel mount connector, unshielded, single wires/M12, C型母头直头前锁面板带线, 不带屏蔽

Illustration/尺寸

Product photo/产品图

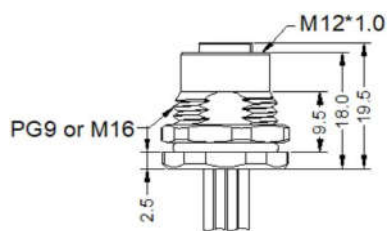

Part number/产品料号

Pins/针数	Code/型	Part number("X" is length millimetre mm)/产品料号("X"表示长度, 单位毫米mm)
		PG9 thread 15.3±0.1/PG9螺纹15.3±0.1
2pins/2针	C code/C型	12D331-X
3pins/3针	C code/C型	12D335-X
4pins/4针	C code/C型	12D339-X
5pins/5针	C code/C型	12D444-X
6pins/6针	C code/C型	12D446-X

Pin assignment front view/针位分布前视图

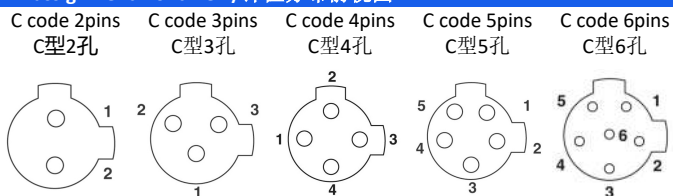

General data/常规数据

Pin Numbers/针数	2pins/2针	3pins/3针	4pins/4针	5pins/5针	6pins/6针
Rated voltage/额定电压	250V			60V	30V
Rated current(40°C)/额定电流	4A				2A
Standards/标准	IEC 61076-2-101				
Termination/焊接方式	solder/焊接				
Degree of protection/防护等级	IP67, IP68, IP69K				
Wire gauge(mm²)/线规(平方数)	0.14mm²-0.75mm²				
Wire gauge(AWG)/线号(平方数)	26AWG-18AWG				
Mechanical operation/插拔次数	>100 mating cycles/大于100次				
Ambient temperature (operation)/操作温度	-25°C~+85°C				
Contact resistance/接触电阻	≤5mΩ				
Insulation resistance/绝缘电阻	≥100MΩ				
Connector body/胶芯	TPU				
Pins/端子	Phosphorus copper with gold plated/磷铜镀金				
Screw/螺丝	Brass with nickel plated/黄铜镀镍				
Environmental compliance/环境符合标准	RoHs, Reach				

M12 C code male straight rear panel mount connector, unshielded, single wires/M12, C型公头直头后锁面板带线, 不带屏蔽

Illustration/尺寸

Product photo/产品图

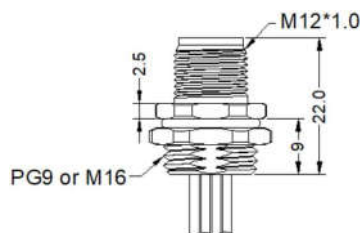

Part number/产品料号

Pins/针数	Code/型	Part number("X" is length millimetre mm)/产品料号("X"表示长度, 单位毫米mm)	
		PG9 thread 15.3±0.1/PG9螺纹15.3±0.1	M16 thread 16±0.1/M16螺纹16±0.1
2pins/2针	C code/C型	12D447-X	12D330-X
3pins/3针	C code/C型	12D449-X	12D334-X
4pins/4针	C code/C型	12D451-X	12D338-X
5pins/5针	C code/C型	12D453-X	12D457-X
6pins/6针	C code/C型	12D455-X	12D459-X

Pin assignment front view/针位分布前视图

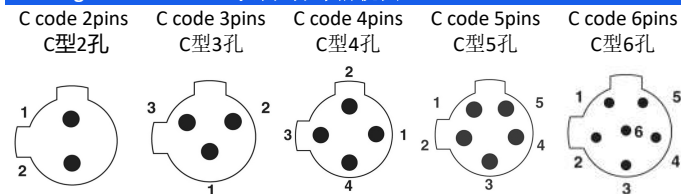

General data/常规数据

Pin Numbers/针数	2pins/2针	3pins/3针	4pins/4针	5pins/5针	6pins/6针
Rated voltage/额定电压	250V			60V	30V
Rated current(40°C)/额定电流	4A				2A
Standards/标准	IEC 61076-2-101				
Termination/焊接方式	solder/焊接				
Degree of protection/防护等级	IP67, IP68, IP69K				
Wire gauge(mm²)/线规(平方数)	0.14mm²-0.75mm²				
Wire gauge(AWG)/线号(平方数)	26AWG-18AWG				
Mechanical operation/插拔次数	>100 mating cycles/大于100次				
Ambient temperature (operation)/操作温度	-25°C~+85°C				
Contact resistance/接触电阻	≤5mΩ				
Insulation resistance/绝缘电阻	≥100MΩ				
Connector body/胶芯	TPU				
Pins/端子	Brass with gold plated/黄铜镀金				
Screw/螺丝	Brass with nickel plated/黄铜镀镍				
Environmental compliance/环境符合标准	RoHs, Reach				

M12 C code female straight rear panel mount connector, unshielded, single wires/M12,C型母头直头后锁面板带线, 不带屏蔽

Illustration/尺寸

Product photo/产品图

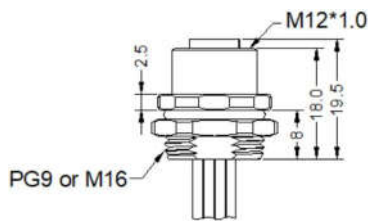

Part number/产品料号

Pins/针数	Code/型	Part number("X" is length millimetre mm)/产品料号("X"表示长度, 单位毫米mm)	
		PG9 thread 15.3±0.1/PG9螺纹15.3±0.1	M16 thread 16±0.1/M16螺纹16±0.1
2pins/2针	C code/C型	12D448-X	12D332-X
3pins/3针	C code/C型	12D450-X	12D336-X
4pins/4针	C code/C型	12D452-X	12D340-X
5pins/5针	C code/C型	12D454-X	12D458-X
6pins/6针	C code/C型	12D456-X	12D460-X

Pin assignment front view/针位分布前视图

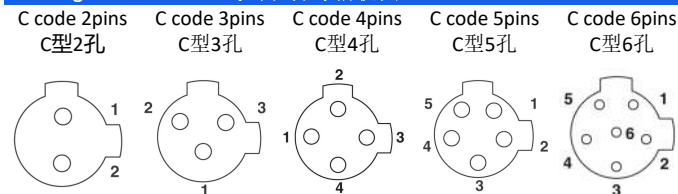

General data/常规数据

Pin Numbers/针数	2pins/2针	3pins/3针	4pins/4针	5pins/5针	6pins/6针
Rated voltage/额定电压	250V			60V	30V
Rated current(40°C)/额定电流	4A				2A
Standards/标准	IEC 61076-2-101				
Termination/焊接方式	solder/焊接				
Degree of protection/防护等级	IP67, IP68, IP69K				
Wire gauge(mm²)/线规(平方数)	0.14mm²-0.75mm²				
Wire gauge(AWG)/线号(平方数)	26AWG-18AWG				
Mechanical operation/插拔次数	>100 mating cycles/大于100次				
Ambient temperature (operation)/操作温度	-25°C~+85°C				
Contact resistance/接触电阻	≤5mΩ				
Insulation resistance/绝缘电阻	≥100MΩ				
Connector body/胶芯	TPU				
Pins/端子	Phosphorus copper with gold plated/磷铜镀金				
Screw/螺丝	Brass with nickel plated/黄铜镀镍				
Environmental compliance/环境符合标准	RoHs, Reach				

M12 C code male straight plastic assembly connector, unshielded/M12, C型公头直头塑胶装配式连接器, 不带屏蔽

Illustration/尺寸

Product photo/产品图

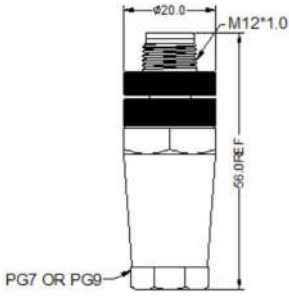

Part number/产品料号

Pins/针数	Code/型	Part number/产品料号	
		PG7 thread/PG7螺纹	PG9 thread/PG9螺纹
2pins/2针	C code/C型	12ZU94-PG7	12ZU94-PG9
3pins/3针	C code/C型	12ZU96-PG7	12ZU96-PG9
4pins/4针	C code/C型	12ZU97-PG7	12ZU97-PG9
5pins/5针	C code/C型	12ZU99-PG7	12ZU99-PG9
6pins/6针	C code/C型	12ZU101-PG7	12ZU101-PG9

Pin assignment front view/针位分布前视图

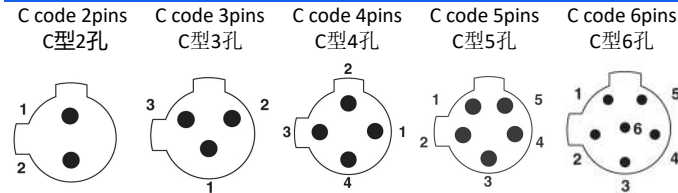

General data/常规数据

Pin Numbers/针数	2pins/2针	3pins/3针	4pins/4针	5pins/5针	6pins/6针
Rated voltage/额定电压	250V			60V	30V
Rated current(40°C)/额定电流	4A				2A
Standards/标准	IEC 61076-2-101				
Termination/焊接方式	solder/焊接				
Degree of protection/防护等级	IP67, IP68, IP69K				
Wire gauge(mm²)/线规(平方数)	0.14mm²-0.75mm²				
Wire gauge(AWG)/线号(平方数)	26AWG-18AWG				
Mechanical operation/插拔次数	>100 mating cycles/大于100次				
Ambient temperature (operation)/操作温度	-25°C~+85°C				
Contact resistance/接触电阻	≤5mΩ				
Insulation resistance/绝缘电阻	≥100MΩ				
Connector body/胶芯	TPU				
Pins/端子	Brass with gold plated/黄铜镀金				
Screw/螺丝	Brass with nickel plated/黄铜镀镍				
Environmental compliance/环境符合标准	RoHs, Reach				

M12 C code female straight plastic assembly connector, unshielded/M12, C型母头直头塑胶装配式连接器, 不带屏蔽

Illustration/尺寸

Product photo/产品图

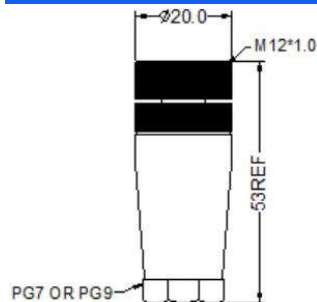

Part number/产品料号

Pins/针数	Code/型	Part number/产品料号	
		PG7 thread/PG7螺纹	PG9 thread/PG9螺纹
2pins/2针	C code/C型	12ZU95-PG7	12ZU95-PG9
3pins/3针	C code/C型	12ZU88-PG7	12ZU88-PG9
4pins/4针	C code/C型	12ZU98-PG7	12ZU98-PG9
5pins/5针	C code/C型	12ZU100-PG7	12ZU100-PG9
6pins/6针	C code/C型	12ZU102-PG7	12ZU102-PG9

Pin assignment front view/针位分布前视图

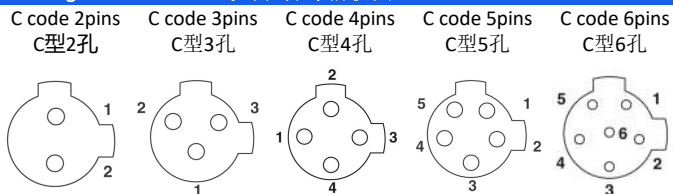

General data/常规数据

Pin Numbers/针数	2pins/2针	3pins/3针	4pins/4针	5pins/5针	6pins/6针
Rated voltage/额定电压	250V			60V	30V
Rated current(40°C)/额定电流	4A				2A
Standards/标准	IEC 61076-2-101				
Termination/焊接方式	solder/焊接				
Degree of protection/防护等级	IP67, IP68, IP69K				
Wire gauge(mm²)/线规(平方数)	0.14mm²-0.75mm²				
Wire gauge(AWG)/线号(平方数)	26AWG-18AWG				
Mechanical operation/插拔次数	>100 mating cycles/大于100次				
Ambient temperature (operation)/操作温度	-25°C~+85°C				
Contact resistance/接触电阻	≤5mΩ				
Insulation resistance/绝缘电阻	≥100MΩ				
Connector body/胶芯	TPU				
Pins/端子	Phosphorus copper with gold plated/磷铜镀金				
Screw/螺丝	Brass with nickel plated/黄铜镀镍				
Environmental compliance/环境符合标准	RoHs, Reach				

M12 C code male right angle plastic assembly connector, unshielded/M12,C型公头弯头塑胶装配式连接器, 不带屏蔽

Illustration/尺寸

Product photo/产品图

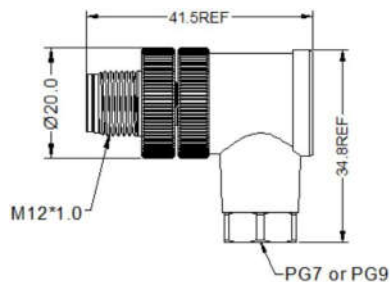

Part number/产品料号

Pins/针数	Code/型	Part number/产品料号	
		PG7 thread/PG7螺纹	PG9 thread/PG9螺纹
2pins/2针	C code/C型	12ZU103-PG7	12ZU103-PG9
3pins/3针	C code/C型	12ZU105-PG7	12ZU105-PG9
4pins/4针	C code/C型	12ZU107-PG7	12ZU107-PG9
5pins/5针	C code/C型	12ZU109-PG7	12ZU109-PG9
6pins/6针	C code/C型	12ZU111-PG7	12ZU111-PG9

Pin assignment front view/针位分布前视图

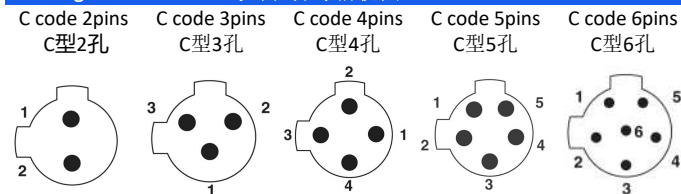

General data/常规数据

Pin Numbers/针数	2pins/2针	3pins/3针	4pins/4针	5pins/5针	6pins/6针
Rated voltage/额定电压	250V			60V	30V
Rated current(40°C)/额定电流	4A				2A
Standards/标准	IEC 61076-2-101				
Termination/焊接方式	solder/焊接				
Degree of protection/防护等级	IP67, IP68, IP69K				
Wire gauge(mm²)/线规(平方数)	0.14mm²-0.75mm²				
Wire gauge(AWG)/线号(平方数)	26AWG-18AWG				
Mechanical operation/插拔次数	>100 mating cycles/大于100次				
Ambient temperature (operation)/操作温度	-25°C~+85°C				
Contact resistance/接触电阻	≤5mΩ				
Insulation resistance/绝缘电阻	≥100MΩ				
Connector body/胶芯	TPU				
Pins/端子	Brass with gold plated/黄铜镀金				
Screw/螺丝	Brass with nickel plated/黄铜镀镍				
Environmental compliance/环境符合标准	RoHs, Reach				

M12 C code female right angle plastic assembly connector, unshielded/M12, C型母头弯头塑胶装配式连接器, 不带屏蔽

Illustration/尺寸

Product photo/产品图

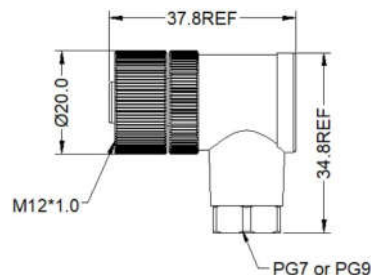

Part number/产品料号

Pins/针数	Code/型	Part number/产品料号	
		PG7 thread/PG7螺纹	PG9 thread/PG9螺纹
2pins/2针	C code/C型	12ZU104-PG7	12ZU104-PG9
3pins/3针	C code/C型	12ZU106-PG7	12ZU106-PG9
4pins/4针	C code/C型	12ZU108-PG7	12ZU108-PG9
5pins/5针	C code/C型	12ZU110-PG7	12ZU110-PG9
6pins/6针	C code/C型	12ZU112-PG7	12ZU112-PG9

Pin assignment front view/针位分布前视图

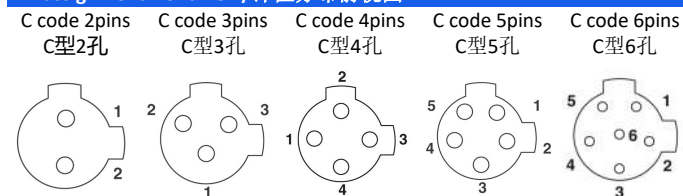

General data/常规数据

Pin Numbers/针数	2pins/2针	3pins/3针	4pins/4针	5pins/5针	6pins/6针
Rated voltage/额定电压	250V			60V	30V
Rated current(40°C)/额定电流	4A				2A
Standards/标准	IEC 61076-2-101				
Termination/焊接方式	solder/焊接				
Degree of protection/防护等级	IP67, IP68, IP69K				
Wire gauge(mm²)/线规(平方数)	0.14mm²-0.75mm²				
Wire gauge(AWG)/线号(平方数)	26AWG-18AWG				
Mechanical operation/插拔次数	>100 mating cycles/大于100次				
Ambient temperature (operation)/操作温度	-25°C~+85°C				
Contact resistance/接触电阻	≤5mΩ				
Insulation resistance/绝缘电阻	≥100MΩ				
Connector body/胶芯	TPU				
Pins/端子	Phosphorus copper with gold plated/磷铜镀金				
Screw/螺丝	Brass with nickel plated/黄铜镀镍				
Environmental compliance/环境符合标准	RoHs, Reach				

M12 C code male straight molded cable, unshielded/M12, C型公头直头成型式连接线, 不带屏蔽

Illustration/尺寸

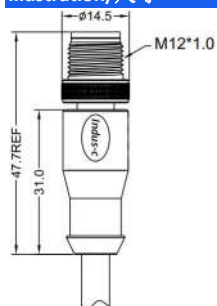

Product photo/产品图



Part number/产品料号

Pins/针数	Code/型	Part number("X" is length millimetre mm)/产品料号("X"表示长度, 单位毫米mm)		
		PVC jacket/PVC外被		PUR jacket/PUR外被
		-10°C~+80°C	-40°C~+105°C	-40°C~+105°C
2pins/2针	C code/C型	12L00036-X	12L00042-X	12L00048-X
3pins/3针	C code/C型	12L00038-X	12L00044-X	12L00050-X
4pins/4针	C code/C型	12L00040-X	12L00046-X	12L00052-X
5pins/5针	C code/C型	12L01009-X	12L01011-X	12L01013-X
6pins/6针	C code/C型	12L01021-X	12L01023-X	12L01025-X

Pin assignment front view/针位分布前视图

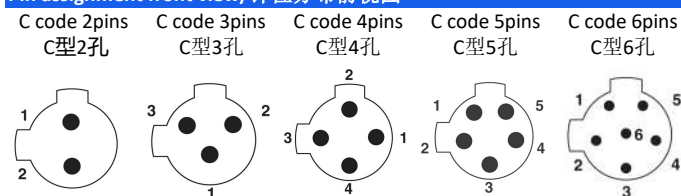

General data/常规数据

Pin Numbers/针数	2pins/2针	3pins/3针	4pins/4针	5pins/5针	6pins/6针
Rated voltage/额定电压	250V			60V	30V
Rated current(40°C)/额定电流	4A				2A
Standards/标准	IEC 61076-2-101				
Termination/焊接方式	solder/焊接				
Degree of protection/防护等级	IP67, IP68, IP69K				
Wire gauge(mm²)/线规(平方数)	0.14mm²-0.75mm²				
Wire gauge(AWG)/线号(平方数)	26AWG-18AWG				
Mechanical operation/插拔次数	>100 mating cycles/大于100次				
Ambient temperature (operation)/操作温度	-25°C~+85°C				
Contact resistance/接触电阻	≤5mΩ				
Insulation resistance/绝缘电阻	≥100MΩ				
Connector body/胶芯	TPU				
Pins/端子	Brass with gold plated/黄铜镀金				
Screw/螺丝	Brass with nickel plated/黄铜镀镍				
Environmental compliance/环境符合标准	RoHS, Reach				

M12 C code female straight molded cable, unshielded/M12, C型母头直头成型式连接线, 不带屏蔽

Illustration/尺寸

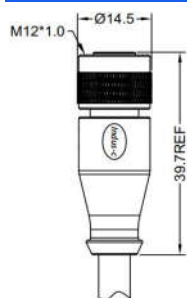

Product photo/产品图



Part number/产品料号

Pins/针数	Code/型	Part number("X" is length millimetre mm)/产品料号("X"表示长度, 单位毫米mm)		
		PVC jacket/PVC外被		PUR jacket/PUR外被
		-10°C~+80°C	-40°C~+105°C	-40°C~+105°C
2pins/2针	C code/C型	12L00037-X	12L00043-X	12L00049-X
3pins/3针	C code/C型	12L00039-X	12L00045-X	12L00051-X
4pins/4针	C code/C型	12L00041-X	12L00047-X	12L00053-X
5pins/5针	C code/C型	12L01010-X	12L01012-X	12L01014-X
6pins/6针	C code/C型	12L01022-X	12L01024-X	12L01026-X

Pin assignment front view/针位分布前视图

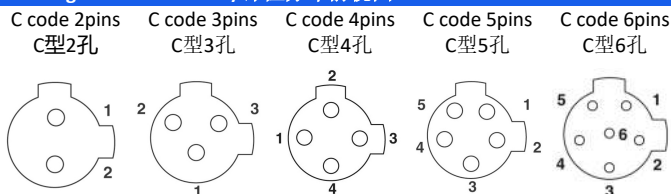

General data/常规数据

Pin Numbers/针数	2pins/2针	3pins/3针	4pins/4针	5pins/5针	6pins/6针
Rated voltage/额定电压	250V			60V	30V
Rated current(40°C)/额定电流	4A				2A
Standards/标准	IEC 61076-2-101				
Termination/焊接方式	solder/焊接				
Degree of protection/防护等级	IP67, IP68, IP69K				
Wire gauge(mm²)/线规(平方数)	0.14mm²-0.75mm²				
Wire gauge(AWG)/线号(平方数)	26AWG-18AWG				
Mechanical operation/插拔次数	>100 mating cycles/大于100次				
Ambient temperature (operation)/操作温度	-25°C~+85°C				
Contact resistance/接触电阻	≤5mΩ				
Insulation resistance/绝缘电阻	≥100MΩ				
Connector body/胶芯	TPU				
Pins/端子	Phosphorus copper with gold plated/磷铜镀金				
Screw/螺丝	Brass with nickel plated/黄铜镀镍				
Environmental compliance/环境符合标准	RoHS, Reach				

M12 C code male straight molded cable, shielded/M12, C型公头直头成型式连接线, 带屏蔽

Illustration/尺寸

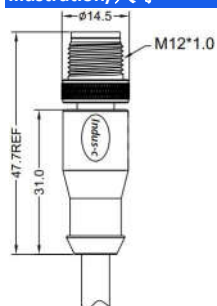

Product photo/产品图



Part number/产品料号

Pins/针数	Code/型	Part number("X" is length millimetre mm)/产品料号("X"表示长度, 单位毫米mm)		
		PVC jacket/PVC外被		PUR jacket/PUR外被
		-10°C~+80°C	-40°C~+105°C	-40°C~+105°C
2pins/2针	C code/C型	12L00054-X	12L00060-X	12L00066-X
3pins/3针	C code/C型	12L00056-X	12L00062-X	12L00068-X
4pins/4针	C code/C型	12L00058-X	12L00064-X	12L00070-X
5pins/5针	C code/C型	12L01033-X	12L01035-X	12L01037-X
6pins/6针	C code/C型	12L01045-X	12L01047-X	12L01049-X

Pin assignment front view/针位分布前视图

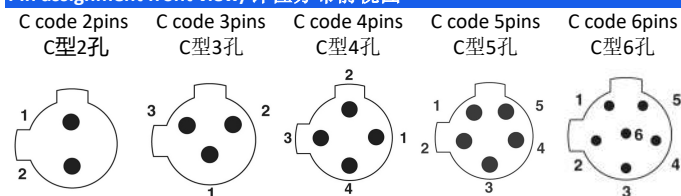

General data/常规数据

Pin Numbers/针数	2pins/2针	3pins/3针	4pins/4针	5pins/5针	6pins/6针
Rated voltage/额定电压	250V			60V	30V
Rated current(40°C)/额定电流	4A				2A
Standards/标准	IEC 61076-2-101				
Termination/焊接方式	solder/焊接				
Degree of protection/防护等级	IP67, IP68, IP69K				
Wire gauge(mm²)/线规(平方数)	0.14mm²-0.75mm²				
Wire gauge(AWG)/线号(平方数)	26AWG-18AWG				
Mechanical operation/插拔次数	>100 mating cycles/大于100次				
Ambient temperature (operation)/操作温度	-25°C~+85°C				
Contact resistance/接触电阻	≤5mΩ				
Insulation resistance/绝缘电阻	≥100MΩ				
Connector body/胶芯	TPU				
Pins/端子	Brass with gold plated/黄铜镀金				
Screw/螺丝	Brass with nickel plated/黄铜镀镍				
Environmental compliance/环境符合标准	RoHS, Reach				

M12 C code female straight molded cable, shielded/M12, C型母头直头成型式连接线, 带屏蔽

Illustration/尺寸

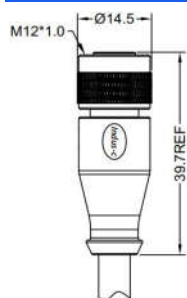

Product photo/产品图



Part number/产品料号

Pins/针数	Code/型	Part number("X" is length millimetre mm)/产品料号("X"表示长度, 单位毫米mm)		
		PVC jacket/PVC外被		PUR jacket/PUR外被
		-10°C~+80°C	-40°C~+105°C	-40°C~+105°C
2pins/2针	C code/C型	12L00055-X	12L00061-X	12L00067-X
3pins/3针	C code/C型	12L00057-X	12L00063-X	12L00069-X
4pins/4针	C code/C型	12L00059-X	12L00065-X	12L00071-X
5pins/5针	C code/C型	12L01034-X	12L01036-X	12L01038-X
6pins/6针	C code/C型	12L01046-X	12L01048-X	12L01050-X

Pin assignment front view/针位分布前视图

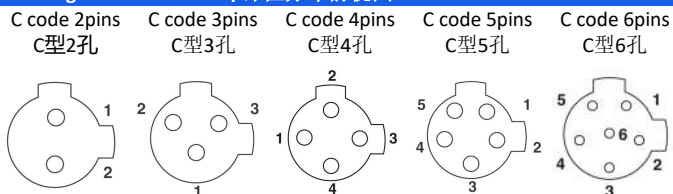

General data/常规数据

Pin Numbers/针数	2pins/2针	3pins/3针	4pins/4针	5pins/5针	6pins/6针
Rated voltage/额定电压	250V			60V	30V
Rated current(40°C)/额定电流	4A			2A	
Standards/标准	IEC 61076-2-101				
Termination/焊接方式	solder/焊接				
Degree of protection/防护等级	IP67, IP68, IP69K				
Wire gauge(mm²)/线规(平方数)	0.14mm²-0.75mm²				
Wire gauge(AWG)/线号(平方数)	26AWG-18AWG				
Mechanical operation/插拔次数	>100 mating cycles/大于100次				
Ambient temperature (operation)/操作温度	-25°C~+85°C				
Contact resistance/接触电阻	≤5mΩ				
Insulation resistance/绝缘电阻	≥100MΩ				
Connector body/胶芯	TPU				
Pins/端子	Phosphorus copper with gold plated/磷铜镀金				
Screw/螺丝	Brass with nickel plated/黄铜镀镍				
Environmental compliance/环境符合标准	RoHS, Reach				

M12 C code male right angle molded cable, unshielded/M12, C型公头弯头成型式连接线, 不带屏蔽

Illustration/尺寸

Product photo/产品图

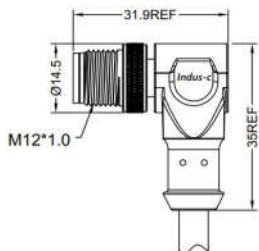

Part number/产品料号

Pins/针数	Code/型	Part number("X" is length millimetre mm)/产品料号("X"表示长度, 单位毫米mm)		
		PVC jacket/PVC外被	PUR jacket/PUR外被	
		-10°C~+80°C	-40°C~+105°C	-40°C~+105°C
2pins/2针	C code/C型	12L00072-X	12L00078-X	12L00084-X
3pins/3针	C code/C型	12L00074-X	12L00080-X	12L00086-X
4pins/4针	C code/C型	12L00076-X	12L00082-X	12L00088-X
5pins/5针	C code/C型	12L01015-X	12L01017-X	12L01019-X
6pins/6针	C code/C型	12L01027-X	12L01029-X	12L01031-X

Pin assignment front view/针位分布前视图

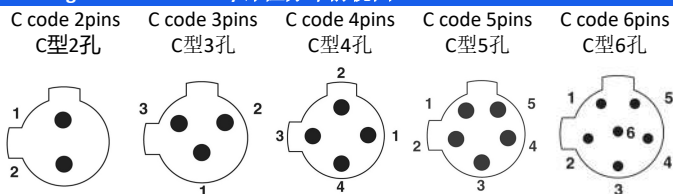

General data/常规数据

Pin Numbers/针数	2pins/2针	3pins/3针	4pins/4针	5pins/5针	6pins/6针
Rated voltage/额定电压	250V			60V	30V
Rated current(40°C)/额定电流	4A			2A	
Standards/标准	IEC 61076-2-101				
Termination/焊接方式	solder/焊接				
Degree of protection/防护等级	IP67, IP68, IP69K				
Wire gauge(mm²)/线规(平方数)	0.14mm²-0.75mm²				
Wire gauge(AWG)/线号(平方数)	26AWG-18AWG				
Mechanical operation/插拔次数	>100 mating cycles/大于100次				
Ambient temperature (operation)/操作温度	-25°C~+85°C				
Contact resistance/接触电阻	≤5mΩ				
Insulation resistance/绝缘电阻	≥100MΩ				
Connector body/胶芯	TPU				
Pins/端子	Brass with gold plated/黄铜镀金				
Screw/螺丝	Brass with nickel plated/黄铜镀镍				
Environmental compliance/环境符合标准	RoHS, Reach				

M12 C code female right angle molded cable, unshielded/M12, C型母头弯头成型式连接线, 不带屏蔽

Illustration/尺寸

Product photo/产品图

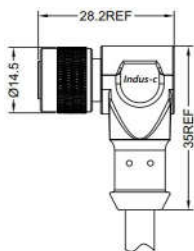

Part number/产品料号

Pins/针数	Code/型	Part number("X" is length millimetre mm)/产品料号("X"表示长度, 单位毫米mm)		
		PVC jacket/PVC外被		PUR jacket/PUR外被
		-10°C~+80°C	-40°C~+105°C	-40°C~+105°C
2pins/2针	C code/C型	12L00073-X	12L00079-X	12L00085-X
3pins/3针	C code/C型	12L00075-X	12L00081-X	12L00087-X
4pins/4针	C code/C型	12L00077-X	12L00083-X	12L00089-X
5pins/5针	C code/C型	12L01016-X	12L01018-X	12L01020-X
6pins/6针	C code/C型	12L01028-X	12L01030-X	12L01032-X

Pin assignment front view/针位分布前视图

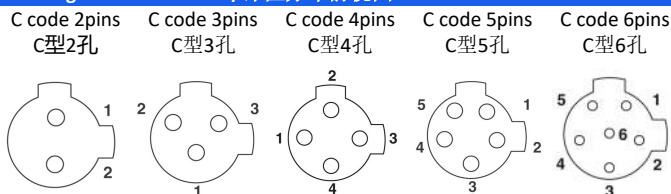

General data/常规数据

Pin Numbers/针数	2pins/2针	3pins/3针	4pins/4针	5pins/5针	6pins/6针
Rated voltage/额定电压	250V			60V	30V
Rated current(40°C)/额定电流	4A			2A	
Standards/标准	IEC 61076-2-101				
Termination/焊接方式	solder/焊接				
Degree of protection/防护等级	IP67, IP68, IP69K				
Wire gauge(mm²)/线规(平方数)	0.14mm²-0.75mm²				
Wire gauge(AWG)/线号(平方数)	26AWG-18AWG				
Mechanical operation/插拔次数	>100 mating cycles/大于100次				
Ambient temperature (operation)/操作温度	-25°C~+85°C				
Contact resistance/接触电阻	≤5mΩ				
Insulation resistance/绝缘电阻	≥100MΩ				
Connector body/胶芯	TPU				
Pins/端子	Phosphorus copper with gold plated/磷铜镀金				
Screw/螺丝	Brass with nickel plated/黄铜镀镍				
Environmental compliance/环境符合标准	RoHS, Reach				

M12 C code male right angle molded cable, shielded/M12, C型公头弯头成型式连接线, 带屏蔽

Illustration/尺寸

Product photo/产品图

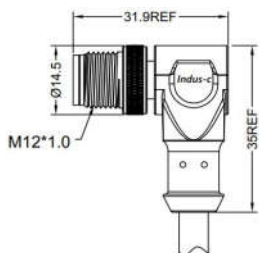

Part number/产品料号

Pins/针数	Code/型	Part number("X" is length millimetre mm)/产品料号("X"表示长度, 单位毫米mm)		
		PVC jacket/PVC外被	PUR jacket/PUR外被	
		-10°C~+80°C	-40°C~+105°C	-40°C~+105°C
2pins/2针	C code/C型	12L00090-X	12L00096-X	12L00102-X
3pins/3针	C code/C型	12L00092-X	12L00098-X	12L00104-X
4pins/4针	C code/C型	12L00094-X	12L00100-X	12L00106-X
5pins/5针	C code/C型	12L01039-X	12L01041-X	12L01043-X
6pins/6针	C code/C型	12L01051-X	12L01053-X	12L01055-X

Pin assignment front view/针位分布前视图

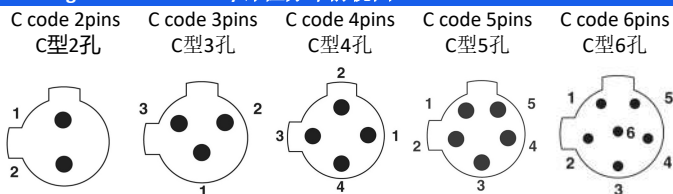

General data/常规数据

Pin Numbers/针数	2pins/2针	3pins/3针	4pins/4针	5pins/5针	6pins/6针
Rated voltage/额定电压	250V			60V	30V
Rated current(40°C)/额定电流	4A			2A	
Standards/标准	IEC 61076-2-101				
Termination/焊接方式	solder/焊接				
Degree of protection/防护等级	IP67, IP68, IP69K				
Wire gauge(mm²)/线规(平方数)	0.14mm²-0.75mm²				
Wire gauge(AWG)/线号(平方数)	26AWG-18AWG				
Mechanical operation/插拔次数	>100 mating cycles/大于100次				
Ambient temperature (operation)/操作温度	-25°C~+85°C				
Contact resistance/接触电阻	≤5mΩ				
Insulation resistance/绝缘电阻	≥100MΩ				
Connector body/胶芯	TPU				
Pins/端子	Brass with gold plated/黄铜镀金				
Screw/螺丝	Brass with nickel plated/黄铜镀镍				
Environmental compliance/环境符合标准	RoHS, Reach				

M12 C code female right angle molded cable, shielded/M12,C型母头弯头成型式连接线, 带屏蔽

Illustration/尺寸

Product photo/产品图

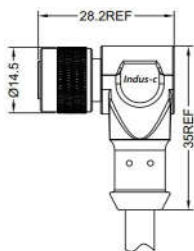

Part number/产品料号

Pins/针数	Code/型	Part number("X" is length millimetre mm)/产品料号("X"表示长度, 单位毫米mm)		
		PVC jacket/PVC外被		PUR jacket/PUR外被
		-10°C~+80°C	-40°C~+105°C	-40°C~+105°C
2pins/2针	C code/C型	12L00091-X	12L00097-X	12L00103-X
3pins/3针	C code/C型	12L00093-X	12L00099-X	12L00105-X
4pins/4针	C code/C型	12L00095-X	12L00101-X	12L00107-X
5pins/5针	C code/C型	12L01040-X	12L01042-X	12L01044-X
6pins/6针	C code/C型	12L01052-X	12L01054-X	12L01056-X

Pin assignment front view/针位分布前视图

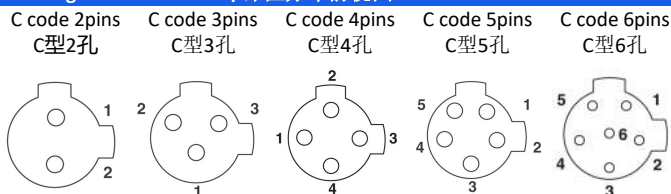

General data/常规数据

Pin Numbers/针数	2pins/2针	3pins/3针	4pins/4针	5pins/5针	6pins/6针
Rated voltage/额定电压	250V			60V	30V
Rated current(40°C)/额定电流	4A			2A	
Standards/标准	IEC 61076-2-101				
Termination/焊接方式	solder/焊接				
Degree of protection/防护等级	IP67, IP68, IP69K				
Wire gauge(mm²)/线规(平方数)	0.14mm²-0.75mm²				
Wire gauge(AWG)/线号(平方数)	26AWG-18AWG				
Mechanical operation/插拔次数	>100 mating cycles/大于100次				
Ambient temperature (operation)/操作温度	-25°C~+85°C				
Contact resistance/接触电阻	≤5mΩ				
Insulation resistance/绝缘电阻	≥100MΩ				
Connector body/胶芯	TPU				
Pins/端子	Phosphorus copper with gold plated/磷铜镀金				
Screw/螺丝	Brass with nickel plated/黄铜镀镍				
Environmental compliance/环境符合标准	RoHS, Reach				

M12 C code male to male right angle molded cable, unshielded/M12, C型公头弯头对公头弯头连接线, 不带屏蔽

Illustration/尺寸

Product photo/产品图

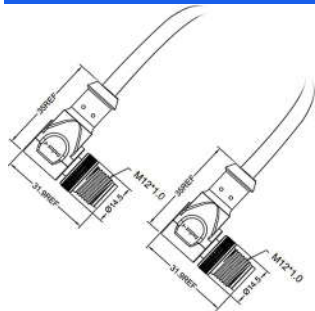

Part number/产品料号

Pins/针数	Code/型	Part number("X" is length millimetre mm)/产品料号("X"表示长度, 单位毫米mm)		
		PVC jacket/PVC外被	PUR jacket/PUR外被	
		-10°C~+80°C	-40°C~+105°C	-40°C~+105°C
2pins/2针	C code/C型	12L01057-X	12L01058-X	12L01059-X
3pins/3针	C code/C型	12L01087-X	12L01088-X	12L01089-X
4pins/4针	C code/C型	12L01117-X	12L01118-X	12L01119-X
5pins/5针	C code/C型	12L01147-X	12L01148-X	12L01149-X
6pins/6针	C code/C型	12L01177-X	12L01178-X	12L01179-X

Pin assignment front view/针位分布前视图

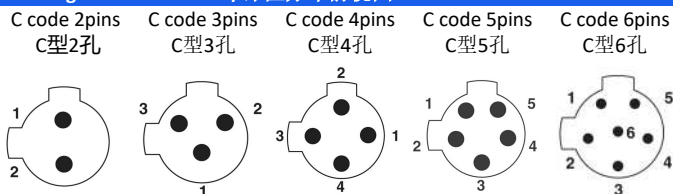

General data/常规数据

Pin Numbers/针数	2pins/2针	3pins/3针	4pins/4针	5pins/5针	6pins/6针
Rated voltage/额定电压	250V			60V	30V
Rated current(40°C)/额定电流	4A				2A
Standards/标准	IEC 61076-2-101				
Termination/焊接方式	solder/焊接				
Degree of protection/防护等级	IP67, IP68, IP69K				
Wire gauge(mm²)/线规(平方数)	0.14mm²-0.75mm²				
Wire gauge(AWG)/线号(平方数)	26AWG-18AWG				
Mechanical operation/插拔次数	>100 mating cycles/大于100次				
Ambient temperature (operation)/操作温度	-25°C~+85°C				
Contact resistance/接触电阻	≤5mΩ				
Insulation resistance/绝缘电阻	≥100MΩ				
Connector body/胶芯	TPU				
Pins/端子	Brass with gold plated/黄铜镀金				
Screw/螺丝	Brass with nickel plated/黄铜镀镍				
Environmental compliance/环境符合标准	RoHS, Reach				

M12 C code male to female right angle molded cable, unshielded/M12, C型公头弯头对母头弯头连接线, 不带屏蔽

Illustration/尺寸

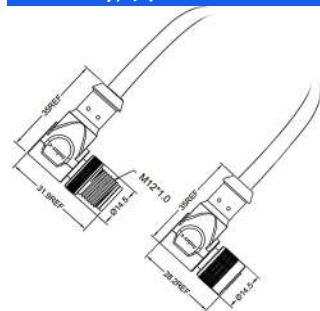

Product photo/产品图



Part number/产品料号

Pins/针数	Code/型	Part number("X" is length millimetre mm)/产品料号("X"表示长度, 单位毫米mm)		
		PVC jacket/PVC外被		PUR jacket/PUR外被
		-10°C~+80°C	-40°C~+105°C	-40°C~+105°C
2pins/2针	C code/C型	12L01060-X	12L01061-X	12L01062-X
3pins/3针	C code/C型	12L01090-X	12L01091-X	12L01092-X
4pins/4针	C code/C型	12L01120-X	12L01121-X	12L01122-X
5pins/5针	C code/C型	12L01150-X	12L01151-X	12L01152-X
6pins/6针	C code/C型	12L01180-X	12L01181-X	12L01182-X

Pin assignment front view/针位分布前视图

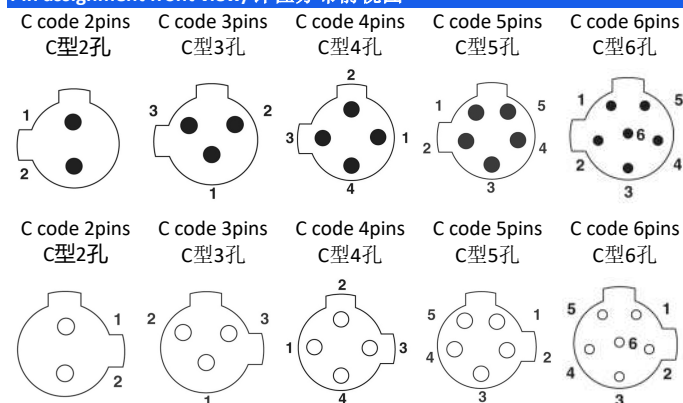

General data/常规数据

Pin Numbers/针数	2pins/2针	3pins/3针	4pins/4针	5pins/5针	6pins/6针
Rated voltage/额定电压	250V			60V	30V
Rated current(40°C)/额定电流	4A				2A
Standards/标准	IEC 61076-2-101				
Termination/焊接方式	solder/焊接				
Degree of protection/防护等级	IP67, IP68, IP69K				
Wire gauge(mm²)/线规(平方数)	0.14mm²-0.75mm²				
Wire gauge(AWG)/线号(平方数)	26AWG-18AWG				
Mechanical operation/插拔次数	>100 mating cycles/大于100次				
Ambient temperature (operation)/操作温度	-25°C~+85°C				
Contact resistance/接触电阻	≤5mΩ				
Insulation resistance/绝缘电阻	≥100MΩ				
Connector body/胶芯	TPU				
Male pin/公端子	Brass with gold plated/黄铜镀金				
Female pin/母端子	Phosphorus copper with gold plated/磷铜镀金				
Screw/螺丝	Brass with nickel plated/黄铜镀镍				
Environmental compliance/环境符合标准	RoHs, Reach				

M12 C code male right angle to female straight molded cable, unshielded/M12, C型公头弯头对母头直头成型式连接线, 不带屏蔽

Illustration/尺寸

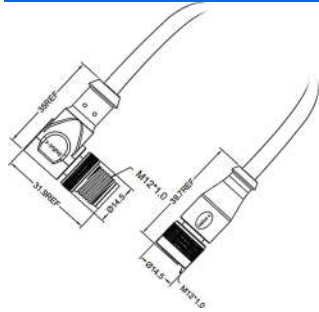

Product photo/产品图



Part number/产品料号

Pins/针数	Code/型	Part number("X" is length millimetre mm)/产品料号("X"表示长度, 单位毫米mm)		
		PVC jacket/PVC外被		PUR jacket/PUR外被
		-10°C~+80°C	-40°C~+105°C	-40°C~+105°C
2pins/2针	C code/C型	12L01063-X	12L01064-X	12L01065-X
3pins/3针	C code/C型	12L01093-X	12L01094-X	12L01095-X
4pins/4针	C code/C型	12L01123-X	12L01124-X	12L01125-X
5pins/5针	C code/C型	12L01153-X	12L01154-X	12L01155-X
6pins/6针	C code/C型	12L01183-X	12L01184-X	12L01185-X

Pin assignment front view/针位分布前视图

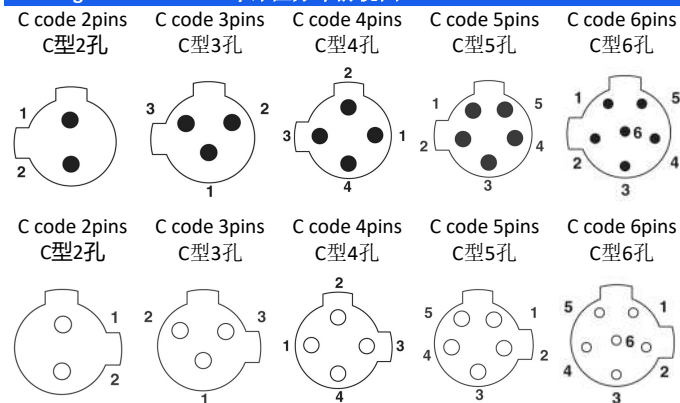

General data/常规数据

Pin Numbers/针数	2pins/2针	3pins/3针	4pins/4针	5pins/5针	6pins/6针
Rated voltage/额定电压	250V			60V	30V
Rated current(40°C)/额定电流	4A			2A	
Standards/标准	IEC 61076-2-101				
Termination/焊接方式	solder/焊接				
Degree of protection/防护等级	IP67, IP68, IP69K				
Wire gauge(mm²)/线规(平方数)	0.14mm²-0.75mm²				
Wire gauge(AWG)/线号(平方数)	26AWG-18AWG				
Mechanical operation/插拔次数	>100 mating cycles/大于100次				
Ambient temperature (operation)/操作温度	-25°C~+85°C				
Contact resistance/接触电阻	≤5mΩ				
Insulation resistance/绝缘电阻	≥100MΩ				
Connector body/胶芯	TPU				
Male pin/公端子	Brass with gold plated/黄铜镀金				
Female pin/母端子	Phosphorus copper with gold plated/磷铜镀金				
Screw/螺丝	Brass with nickel plated/黄铜镀镍				
Environmental compliance/环境符合标准	RoHs, Reach				

M12 C code male straight to male right angle molded cable, unshielded/M12, C型公头直头对公头弯头连接线, 不带屏蔽

Illustration/尺寸

Product photo/产品图

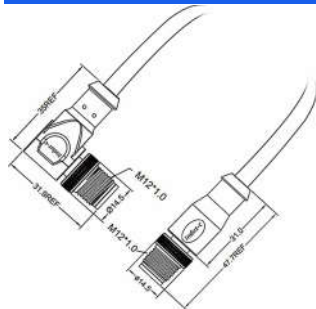

Part number/产品料号

Pins/针数	Code/型	Part number("X" is length millimetre mm)/产品料号("X"表示长度, 单位毫米mm)		
		PVC jacket/PVC外被	PUR jacket/PUR外被	
		-10°C~+80°C	-40°C~+105°C	-40°C~+105°C
2pins/2针	C code/C型	12L01066-X	12L01067-X	12L01068-X
3pins/3针	C code/C型	12L01096-X	12L01097-X	12L01098-X
4pins/4针	C code/C型	12L01126-X	12L01127-X	12L01128-X
5pins/5针	C code/C型	12L01156-X	12L01157-X	12L01158-X
6pins/6针	C code/C型	12L01186-X	12L01187-X	12L01188-X

Pin assignment front view/针位分布前视图

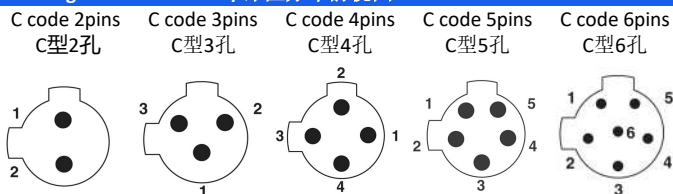

General data/常规数据

Pin Numbers/针数	2pins/2针	3pins/3针	4pins/4针	5pins/5针	6pins/6针
Rated voltage/额定电压	250V			60V	30V
Rated current(40°C)/额定电流	4A				2A
Standards/标准	IEC 61076-2-101				
Termination/焊接方式	solder/焊接				
Degree of protection/防护等级	IP67, IP68, IP69K				
Wire gauge(mm²)/线规(平方数)	0.14mm²-0.75mm²				
Wire gauge(AWG)/线号(平方数)	26AWG-18AWG				
Mechanical operation/插拔次数	>100 mating cycles/大于100次				
Ambient temperature (operation)/操作温度	-25°C~+85°C				
Contact resistance/接触电阻	≤5mΩ				
Insulation resistance/绝缘电阻	≥100MΩ				
Connector body/胶芯	TPU				
Pins/端子	Brass with gold plated/黄铜镀金				
Screw/螺丝	Brass with nickel plated/黄铜镀镍				
Environmental compliance/环境符合标准	RoHS, Reach				

M12 C code male to male straight molded cable, unshielded/M12, C型公头直头对公头直头连接线, 不带屏蔽

Illustration/尺寸

Product photo/产品图

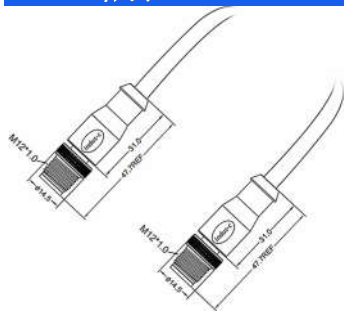

Part number/产品料号

Pins/针数	Code/型	Part number("X" is length millimetre mm)/产品料号("X"表示长度, 单位毫米mm)		
		PVC jacket/PVC外被	PUR jacket/PUR外被	
		-10°C~+80°C	-40°C~+105°C	-40°C~+105°C
2pins/2针	C code/C型	12L01069-X	12L01070-X	12L01071-X
3pins/3针	C code/C型	12L01099-X	12L01100-X	12L01101-X
4pins/4针	C code/C型	12L01129-X	12L01130-X	12L01131-X
5pins/5针	C code/C型	12L01159-X	12L01160-X	12L01161-X
6pins/6针	C code/C型	12L01189-X	12L01190-X	12L01191-X

Pin assignment front view/针位分布前视图

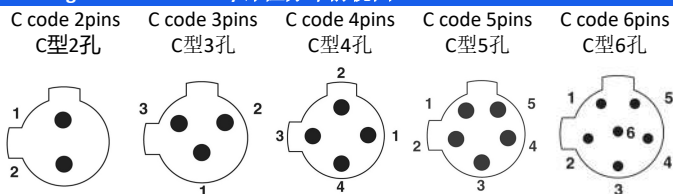

General data/常规数据

Pin Numbers/针数	2pins/2针	3pins/3针	4pins/4针	5pins/5针	6pins/6针
Rated voltage/额定电压	250V			60V	30V
Rated current(40°C)/额定电流	4A				2A
Standards/标准	IEC 61076-2-101				
Termination/焊接方式	solder/焊接				
Degree of protection/防护等级	IP67, IP68, IP69K				
Wire gauge(mm²)/线规(平方数)	0.14mm²-0.75mm²				
Wire gauge(AWG)/线号(平方数)	26AWG-18AWG				
Mechanical operation/插拔次数	>100 mating cycles/大于100次				
Ambient temperature (operation)/操作温度	-25°C~+85°C				
Contact resistance/接触电阻	≤5mΩ				
Insulation resistance/绝缘电阻	≥100MΩ				
Connector body/胶芯	TPU				
Pins/端子	Brass with gold plated/黄铜镀金				
Screw/螺丝	Brass with nickel plated/黄铜镀镍				
Environmental compliance/环境符合标准	RoHS, Reach				

M12 C code male straight to female right angle molded cable, unshielded/M12, C型公头直头对母头弯头连接线, 不带屏蔽

Illustration/尺寸

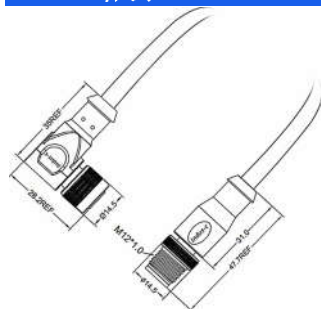

Product photo/产品图



Part number/产品料号

Pins/针数	Code/型	Part number("X" is length millimetre mm)/产品料号("X"表示长度, 单位毫米mm)		
		PVC jacket/PVC外被	PUR jacket/PUR外被	
		-10°C~+80°C	-40°C~+105°C	-40°C~+105°C
2pins/2针	C code/C型	12L01072-X	12L01073-X	12L01074-X
3pins/3针	C code/C型	12L01102-X	12L01103-X	12L01104-X
4pins/4针	C code/C型	12L01132-X	12L01133-X	12L01134-X
5pins/5针	C code/C型	12L01162-X	12L01163-X	12L01164-X
6pins/6针	C code/C型	12L01192-X	12L01193-X	12L01194-X

Pin assignment front view/针位分布前视图

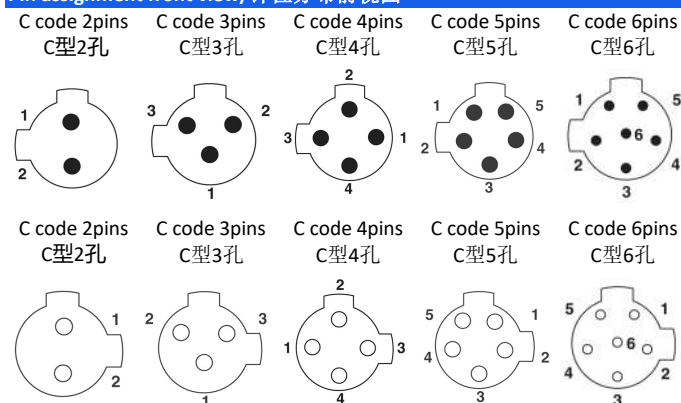

General data/常规数据

Pin Numbers/针数	2pins/2针	3pins/3针	4pins/4针	5pins/5针	6pins/6针
Rated voltage/额定电压	250V			60V	30V
Rated current(40°C)/额定电流	4A			2A	
Standards/标准	IEC 61076-2-101				
Termination/焊接方式	solder/焊接				
Degree of protection/防护等级	IP67, IP68, IP69K				
Wire gauge(mm²)/线规(平方数)	0.14mm²-0.75mm²				
Wire gauge(AWG)/线号(平方数)	26AWG-18AWG				
Mechanical operation/插拔次数	>100 mating cycles/大于100次				
Ambient temperature (operation)/操作温度	-25°C~+85°C				
Contact resistance/接触电阻	≤5mΩ				
Insulation resistance/绝缘电阻	≥100MΩ				
Connector body/胶芯	TPU				
Male pin/公端子	Brass with gold plated/黄铜镀金				
Female pin/母端子	Phosphorus copper with gold plated/磷铜镀金				
Screw/螺丝	Brass with nickel plated/黄铜镀镍				
Environmental compliance/环境符合标准	RoHs, Reach				

M12 C code male to female straight molded cable, unshielded/M12, C型公头直头对母头直头连接线, 不带屏蔽

Illustration/尺寸

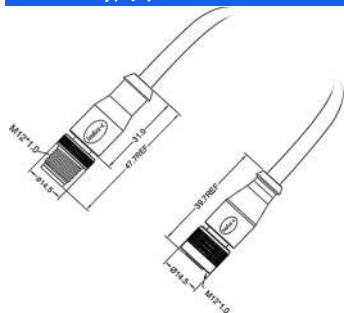

Product photo/产品图



Part number/产品料号

Pins/针数	Code/型	Part number("X" is length millimetre mm)/产品料号("X"表示长度, 单位毫米mm)		
		PVC jacket/PVC外被		PUR jacket/PUR外被
		-10°C~+80°C	-40°C~+105°C	-40°C~+105°C
2pins/2针	C code/C型	12L01075-X	12L01076-X	12L01077-X
3pins/3针	C code/C型	12L01105-X	12L01106-X	12L01107-X
4pins/4针	C code/C型	12L01135-X	12L01136-X	12L01137-X
5pins/5针	C code/C型	12L01165-X	12L01166-X	12L01167-X
6pins/6针	C code/C型	12L01195-X	12L01196-X	12L01197-X

Pin assignment front view/针位分布前视图

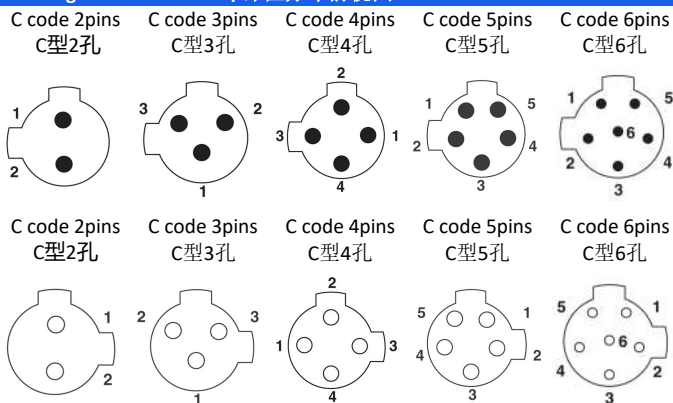

General data/常规数据

Pin Numbers/针数	2pins/2针	3pins/3针	4pins/4针	5pins/5针	6pins/6针
Rated voltage/额定电压	250V			60V	30V
Rated current(40°C)/额定电流	4A				2A
Standards/标准	IEC 61076-2-101				
Termination/焊接方式	solder/焊接				
Degree of protection/防护等级	IP67, IP68, IP69K				
Wire gauge(mm²)/线规(平方数)	0.14mm²-0.75mm²				
Wire gauge(AWG)/线号(平方数)	26AWG-18AWG				
Mechanical operation/插拔次数	>100 mating cycles/大于100次				
Ambient temperature (operation)/操作温度	-25°C~+85°C				
Contact resistance/接触电阻	≤5mΩ				
Insulation resistance/绝缘电阻	≥100MΩ				
Connector body/胶芯	TPU				
Male pin/公端子	Brass with gold plated/黄铜镀金				
Female pin/母端子	Phosphorus copper with gold plated/磷铜镀金				
Screw/螺丝	Brass with nickel plated/黄铜镀镍				
Environmental compliance/环境符合标准	RoHs, Reach				

M12 C code female to female right angle molded cable, unshielded/M12, C型母头弯头对母头弯头连接线, 不带屏蔽

Illustration/尺寸

Product photo/产品图

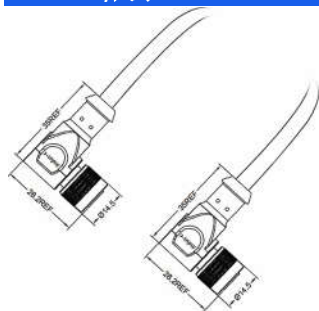

Part number/产品料号

Pins/针数	Code/型	Part number("X" is length millimetre mm)/产品料号("X"表示长度, 单位毫米mm)		
		PVC jacket/PVC外被		PUR jacket/PUR外被
		-10°C~+80°C	-40°C~+105°C	-40°C~+105°C
2pins/2针	C code/C型	12L01078-X	12L01079-X	12L01080-X
3pins/3针	C code/C型	12L01108-X	12L01109-X	12L01110-X
4pins/4针	C code/C型	12L01138-X	12L01139-X	12L01140-X
5pins/5针	C code/C型	12L01168-X	12L01169-X	12L01170-X
6pins/6针	C code/C型	12L01198-X	12L01199-X	12L01200-X

Pin assignment front view/针位分布前视图

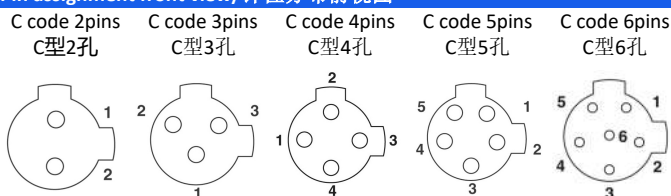

General data/常规数据

Pin Numbers/针数	2pins/2针	3pins/3针	4pins/4针	5pins/5针	6pins/6针
Rated voltage/额定电压	250V			60V	30V
Rated current(40°C)/额定电流	4A				2A
Standards/标准	IEC 61076-2-101				
Termination/焊接方式	solder/焊接				
Degree of protection/防护等级	IP67, IP68, IP69K				
Wire gauge(mm²)/线规(平方数)	0.14mm²-0.75mm²				
Wire gauge(AWG)/线号(平方数)	26AWG-18AWG				
Mechanical operation/插拔次数	>100 mating cycles/大于100次				
Ambient temperature (operation)/操作温度	-25°C~+85°C				
Contact resistance/接触电阻	≤5mΩ				
Insulation resistance/绝缘电阻	≥100MΩ				
Connector body/胶芯	TPU				
Pins/端子	Phosphorus copper with gold plated/磷铜镀金				
Screw/螺丝	Brass with nickel plated/黄铜镀镍				
Environmental compliance/环境符合标准	RoHS, Reach				

M12 C code female straight to female right angle molded cable, unshielded/M12, C型母头直头对母头弯头连接线, 不带屏蔽

Illustration/尺寸

Product photo/产品图

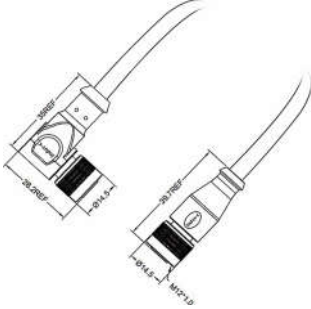

Part number/产品料号

Pins/针数	Code/型	Part number("X" is length millimetre mm)/产品料号("X"表示长度, 单位毫米mm)		
		PVC jacket/PVC外被		PUR jacket/PUR外被
		-10°C~+80°C	-40°C~+105°C	-40°C~+105°C
2pins/2针	C code/C型	12L01081-X	12L01082-X	12L01083-X
3pins/3针	C code/C型	12L01111-X	12L01112-X	12L01113-X
4pins/4针	C code/C型	12L01141-X	12L01142-X	12L01143-X
5pins/5针	C code/C型	12L01171-X	12L01172-X	12L01173-X
6pins/6针	C code/C型	12L01201-X	12L01202-X	12L01203-X

Pin assignment front view/针位分布前视图

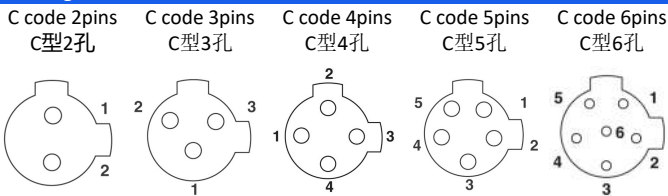

General data/常规数据

Pin Numbers/针数	2pins/2针	3pins/3针	4pins/4针	5pins/5针	6pins/6针
Rated voltage/额定电压	250V			60V	30V
Rated current(40°C)/额定电流	4A				2A
Standards/标准	IEC 61076-2-101				
Termination/焊接方式	solder/焊接				
Degree of protection/防护等级	IP67, IP68, IP69K				
Wire gauge(mm²)/线规(平方数)	0.14mm²-0.75mm²				
Wire gauge(AWG)/线号(平方数)	26AWG-18AWG				
Mechanical operation/插拔次数	>100 mating cycles/大于100次				
Ambient temperature (operation)/操作温度	-25°C~+85°C				
Contact resistance/接触电阻	≤5mΩ				
Insulation resistance/绝缘电阻	≥100MΩ				
Connector body/胶芯	TPU				
Pins/端子	Phosphorus copper with gold plated/磷铜镀金				
Screw/螺丝	Brass with nickel plated/黄铜镀镍				
Environmental compliance/环境符合标准	RoHS, Reach				

M12 C code female to female straight molded cable, unshielded/M12, C型母头直头对母头直头连接线, 不带屏蔽

Illustration/尺寸

Product photo/产品图

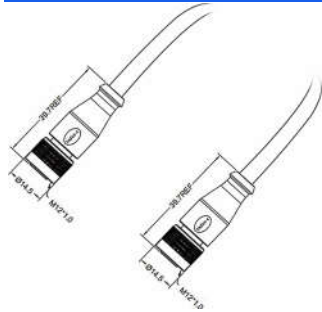

Part number/产品料号

Pins/针数	Code/型	Part number("X" is length millimetre mm)/产品料号("X"表示长度, 单位毫米mm)		
		PVC jacket/PVC外被		PUR jacket/PUR外被
		-10°C~+80°C	-40°C~+105°C	-40°C~+105°C
2pins/2针	C code/C型	12L01084-X	12L01085-X	12L01086-X
3pins/3针	C code/C型	12L01114-X	12L01115-X	12L01116-X
4pins/4针	C code/C型	12L01144-X	12L01145-X	12L01146-X
5pins/5针	C code/C型	12L01174-X	12L01175-X	12L01176-X
6pins/6针	C code/C型	12L01204-X	12L01205-X	12L01206-X

Pin assignment front view/针位分布前视图

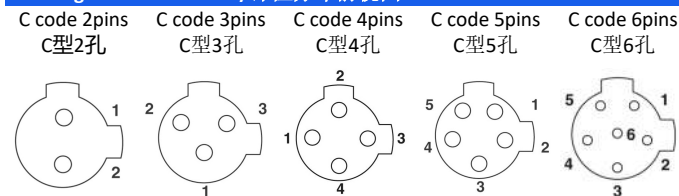

General data/常规数据

Pin Numbers/针数	2pins/2针	3pins/3针	4pins/4针	5pins/5针	6pins/6针
Rated voltage/额定电压	250V			60V	30V
Rated current(40°C)/额定电流	4A				2A
Standards/标准	IEC 61076-2-101				
Termination/焊接方式	solder/焊接				
Degree of protection/防护等级	IP67, IP68, IP69K				
Wire gauge(mm²)/线规(平方数)	0.14mm²-0.75mm²				
Wire gauge(AWG)/线号(平方数)	26AWG-18AWG				
Mechanical operation/插拔次数	>100 mating cycles/大于100次				
Ambient temperature (operation)/操作温度	-25°C~+85°C				
Contact resistance/接触电阻	≤5mΩ				
Insulation resistance/绝缘电阻	≥100MΩ				
Connector body/胶芯	TPU				
Pins/端子	Phosphorus copper with gold plated/磷铜镀金				
Screw/螺丝	Brass with nickel plated/黄铜镀镍				
Environmental compliance/环境符合标准	RoHS, Reach				

M12 C code male to male right angle molded cable, shielded/M12, C型公头弯头对公头弯头连接线, 带屏蔽

Illustration/尺寸

Product photo/产品图

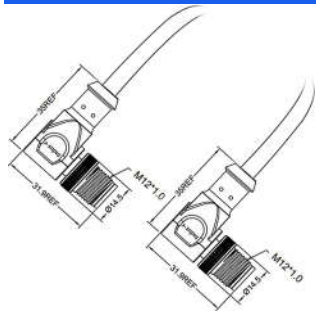

Part number/产品料号

Pins/针数	Code/型	Part number("X" is length millimetre mm)/产品料号("X"表示长度, 单位毫米mm)		
		PVC jacket/PVC外被	PUR jacket/PUR外被	
		-10°C~+80°C	-40°C~+105°C	-40°C~+105°C
2pins/2针	C code/C型	12L01207-X	12L01208-X	12L01209-X
3pins/3针	C code/C型	12L01237-X	12L01238-X	12L01239-X
4pins/4针	C code/C型	12L01267-X	12L01268-X	12L01269-X
5pins/5针	C code/C型	12L01297-X	12L01298-X	12L01299-X
6pins/6针	C code/C型	12L01327-X	12L01328-X	12L01329-X

Pin assignment front view/针位分布前视图

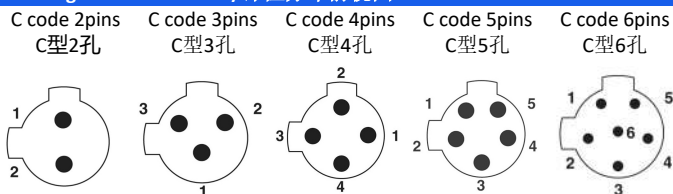

General data/常规数据

Pin Numbers/针数	2pins/2针	3pins/3针	4pins/4针	5pins/5针	6pins/6针
Rated voltage/额定电压	250V			60V	30V
Rated current(40°C)/额定电流	4A				2A
Standards/标准	IEC 61076-2-101				
Termination/焊接方式	solder/焊接				
Degree of protection/防护等级	IP67, IP68, IP69K				
Wire gauge(mm²)/线规(平方数)	0.14mm²-0.75mm²				
Wire gauge(AWG)/线号(平方数)	26AWG-18AWG				
Mechanical operation/插拔次数	>100 mating cycles/大于100次				
Ambient temperature (operation)/操作温度	-25°C~+85°C				
Contact resistance/接触电阻	≤5mΩ				
Insulation resistance/绝缘电阻	≥100MΩ				
Connector body/胶芯	TPU				
Pins/端子	Brass with gold plated/黄铜镀金				
Screw/螺丝	Brass with nickel plated/黄铜镀镍				
Environmental compliance/环境符合标准	RoHS, Reach				

M12 C code male to female right angle molded cable, shielded/M12, C型公头弯头对母头弯头连接线, 带屏蔽

Illustration/尺寸

Product photo/产品图

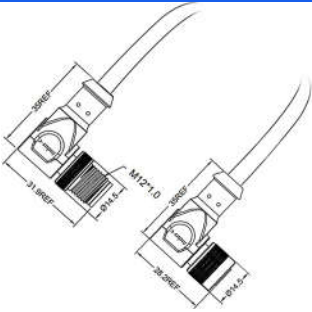

Part number/产品料号

Pins/针数	Code/型	Part number("X" is length millimetre mm)/产品料号("X"表示长度, 单位毫米mm)		
		PVC jacket/PVC外被		PUR jacket/PUR外被
		-10°C~+80°C	-40°C~+105°C	-40°C~+105°C
2pins/2针	C code/C型	12L01210-X	12L01211-X	12L01212-X
3pins/3针	C code/C型	12L01240-X	12L01241-X	12L01242-X
4pins/4针	C code/C型	12L01270-X	12L01271-X	12L01272-X
5pins/5针	C code/C型	12L01300-X	12L01301-X	12L01302-X
6pins/6针	C code/C型	12L01330-X	12L01331-X	12L01332-X

Pin assignment front view/针位分布前视图

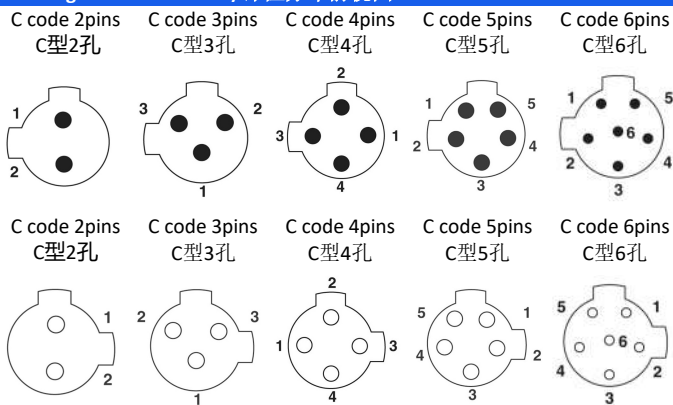

General data/常规数据

Pin Numbers/针数	2pins/2针	3pins/3针	4pins/4针	5pins/5针	6pins/6针
Rated voltage/额定电压	250V			60V	30V
Rated current(40°C)/额定电流	4A				2A
Standards/标准	IEC 61076-2-101				
Termination/焊接方式	solder/焊接				
Degree of protection/防护等级	IP67, IP68, IP69K				
Wire gauge(mm²)/线规(平方数)	0.14mm²-0.75mm²				
Wire gauge(AWG)/线号(平方数)	26AWG-18AWG				
Mechanical operation/插拔次数	>100 mating cycles/大于100次				
Ambient temperature (operation)/操作温度	-25°C~+85°C				
Contact resistance/接触电阻	≤5mΩ				
Insulation resistance/绝缘电阻	≥100MΩ				
Connector body/胶芯	TPU				
Male pin/公端子	Brass with gold plated/黄铜镀金				
Female pin/母端子	Phosphorus copper with gold plated/磷铜镀金				
Screw/螺丝	Brass with nickel plated/黄铜镀镍				
Environmental compliance/环境符合标准	RoHs, Reach				

M12 C code male right angle to female straight molded cable, shielded/M12, C型公头弯头对母头直头成型式连接线, 带屏蔽

Illustration/尺寸

Product photo/产品图

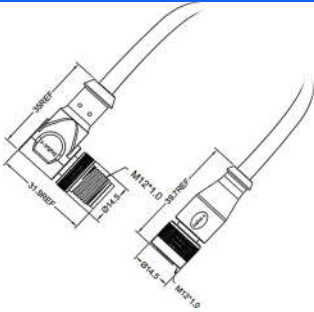

Part number/产品料号

Pins/针数	Code/型	Part number("X" is length millimetre mm)/产品料号("X"表示长度, 单位毫米mm)		
		PVC jacket/PVC外被	PUR jacket/PUR外被	
		-10°C~+80°C	-40°C~+105°C	-40°C~+105°C
2pins/2针	C code/C型	12L01213-X	12L01214-X	12L01215-X
3pins/3针	C code/C型	12L01243-X	12L01244-X	12L01245-X
4pins/4针	C code/C型	12L01273-X	12L01274-X	12L01275-X
5pins/5针	C code/C型	12L01303-X	12L01304-X	12L01305-X
6pins/6针	C code/C型	12L01333-X	12L01334-X	12L01335-X

Pin assignment front view/针位分布前视图

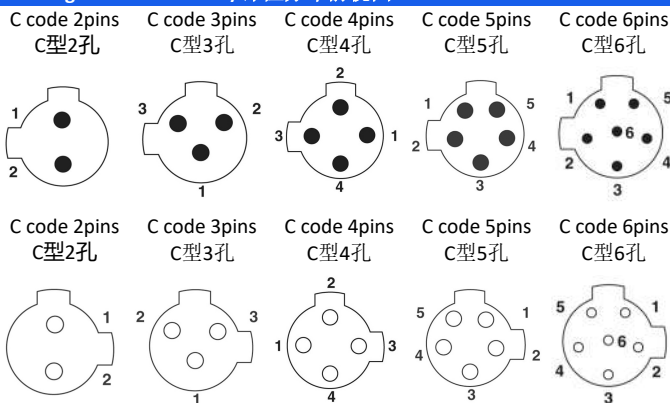

General data/常规数据

Pin Numbers/针数	2pins/2针	3pins/3针	4pins/4针	5pins/5针	6pins/6针
Rated voltage/额定电压	250V			60V	30V
Rated current(40°C)/额定电流	4A			2A	
Standards/标准	IEC 61076-2-101				
Termination/焊接方式	solder/焊接				
Degree of protection/防护等级	IP67, IP68, IP69K				
Wire gauge(mm²)/线规(平方数)	0.14mm²-0.75mm²				
Wire gauge(AWG)/线号(平方数)	26AWG-18AWG				
Mechanical operation/插拔次数	>100 mating cycles/大于100次				
Ambient temperature (operation)/操作温度	-25°C~+85°C				
Contact resistance/接触电阻	≤5mΩ				
Insulation resistance/绝缘电阻	≥100MΩ				
Connector body/胶芯	TPU				
Male pin/公端子	Brass with gold plated/黄铜镀金				
Female pin/母端子	Phosphorus copper with gold plated/磷铜镀金				
Screw/螺丝	Brass with nickel plated/黄铜镀镍				
Environmental compliance/环境符合标准	RoHs, Reach				

M12 C code male straight to male right angle molded cable, shielded/M12, C型公头直头对公头弯头连接线, 带屏蔽

Illustration/尺寸

Product photo/产品图

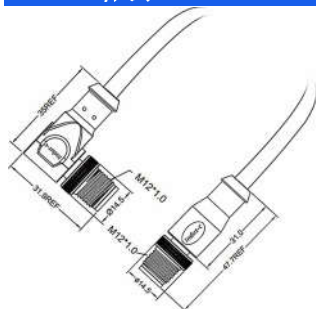

Part number/产品料号

Pins/针数	Code/型	Part number("X" is length millimetre mm)/产品料号("X"表示长度, 单位毫米mm)		
		PVC jacket/PVC外被	PUR jacket/PUR外被	
		-10°C~+80°C	-40°C~+105°C	-40°C~+105°C
2pins/2针	C code/C型	12L01216-X	12L01217-X	12L01218-X
3pins/3针	C code/C型	12L01246-X	12L01247-X	12L01248-X
4pins/4针	C code/C型	12L01276-X	12L01277-X	12L01278-X
5pins/5针	C code/C型	12L01306-X	12L01307-X	12L01308-X
6pins/6针	C code/C型	12L01336-X	12L01337-X	12L01338-X

Pin assignment front view/针位分布前视图

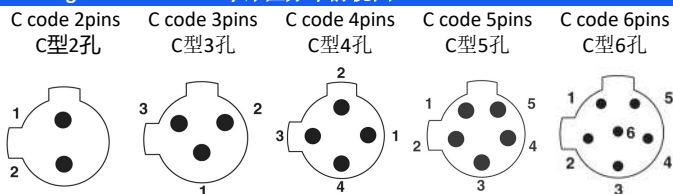

General data/常规数据

Pin Numbers/针数	2pins/2针	3pins/3针	4pins/4针	5pins/5针	6pins/6针
Rated voltage/额定电压	250V			60V	30V
Rated current(40°C)/额定电流	4A				2A
Standards/标准	IEC 61076-2-101				
Termination/焊接方式	solder/焊接				
Degree of protection/防护等级	IP67, IP68, IP69K				
Wire gauge(mm²)/线规(平方数)	0.14mm²-0.75mm²				
Wire gauge(AWG)/线号(平方数)	26AWG-18AWG				
Mechanical operation/插拔次数	>100 mating cycles/大于100次				
Ambient temperature (operation)/操作温度	-25°C~+85°C				
Contact resistance/接触电阻	≤5mΩ				
Insulation resistance/绝缘电阻	≥100MΩ				
Connector body/胶芯	TPU				
Pins/端子	Brass with gold plated/黄铜镀金				
Screw/螺丝	Brass with nickel plated/黄铜镀镍				
Environmental compliance/环境符合标准	RoHS, Reach				

M12 C code male to male straight molded cable, shielded/M12, C型公头直头对公头直头连接线, 带屏蔽

Illustration/尺寸

Product photo/产品图

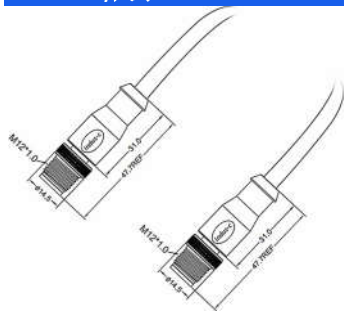

Part number/产品料号

Pins/针数	Code/型	Part number("X" is length millimetre mm)/产品料号("X"表示长度, 单位毫米mm)		
		PVC jacket/PVC外被	PUR jacket/PUR外被	
		-10°C~+80°C	-40°C~+105°C	-40°C~+105°C
2pins/2针	C code/C型	12L01219-X	12L01220-X	12L01221-X
3pins/3针	C code/C型	12L01249-X	12L01250-X	12L01251-X
4pins/4针	C code/C型	12L01279-X	12L01280-X	12L01281-X
5pins/5针	C code/C型	12L01309-X	12L01310-X	12L01311-X
6pins/6针	C code/C型	12L01339-X	12L01340-X	12L01341-X

Pin assignment front view/针位分布前视图

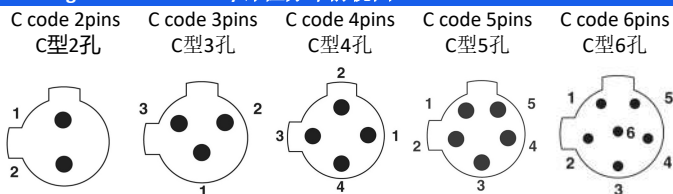

General data/常规数据

Pin Numbers/针数	2pins/2针	3pins/3针	4pins/4针	5pins/5针	6pins/6针
Rated voltage/额定电压	250V			60V	30V
Rated current(40°C)/额定电流	4A				2A
Standards/标准	IEC 61076-2-101				
Termination/焊接方式	solder/焊接				
Degree of protection/防护等级	IP67, IP68, IP69K				
Wire gauge(mm²)/线规(平方数)	0.14mm²-0.75mm²				
Wire gauge(AWG)/线号(平方数)	26AWG-18AWG				
Mechanical operation/插拔次数	>100 mating cycles/大于100次				
Ambient temperature (operation)/操作温度	-25°C~+85°C				
Contact resistance/接触电阻	≤5mΩ				
Insulation resistance/绝缘电阻	≥100MΩ				
Connector body/胶芯	TPU				
Pins/端子	Brass with gold plated/黄铜镀金				
Screw/螺丝	Brass with nickel plated/黄铜镀镍				
Environmental compliance/环境符合标准	RoHS, Reach				

M12 C code male straight to female right angle molded cable, shielded/M12, C型公头直头对母头弯头连接线, 带屏蔽

Illustration/尺寸

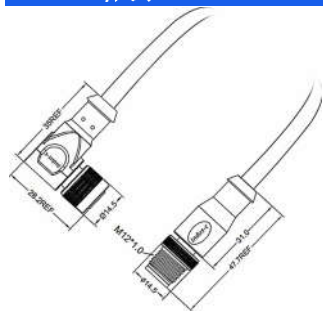

Product photo/产品图



Part number/产品料号

Pins/针数	Code/型	Part number("X" is length millimetre mm)/产品料号("X"表示长度, 单位毫米mm)		
		PVC jacket/PVC外被	PUR jacket/PUR外被	
		-10°C~+80°C	-40°C~+105°C	-40°C~+105°C
2pins/2针	C code/C型	12L01222-X	12L01223-X	12L01224-X
3pins/3针	C code/C型	12L01252-X	12L01253-X	12L01254-X
4pins/4针	C code/C型	12L01282-X	12L01283-X	12L01284-X
5pins/5针	C code/C型	12L01312-X	12L01313-X	12L01314-X
6pins/6针	C code/C型	12L01342-X	12L01343-X	12L01344-X

Pin assignment front view/针位分布前视图

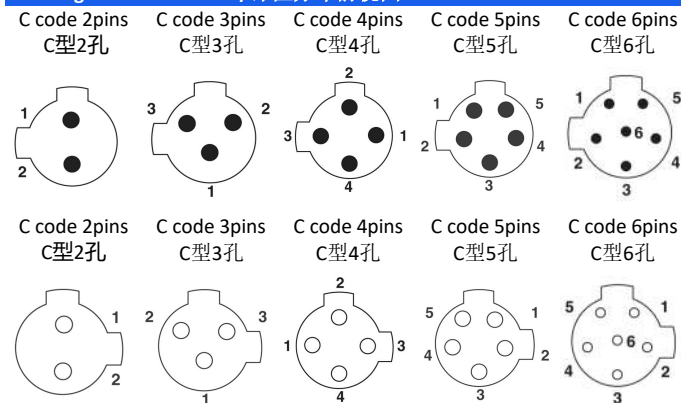

General data/常规数据

Pin Numbers/针数	2pins/2针	3pins/3针	4pins/4针	5pins/5针	6pins/6针
Rated voltage/额定电压	250V			60V	30V
Rated current(40°C)/额定电流	4A				2A
Standards/标准	IEC 61076-2-101				
Termination/焊接方式	solder/焊接				
Degree of protection/防护等级	IP67, IP68, IP69K				
Wire gauge(mm²)/线规(平方数)	0.14mm²-0.75mm²				
Wire gauge(AWG)/线号(平方数)	26AWG-18AWG				
Mechanical operation/插拔次数	>100 mating cycles/大于100次				
Ambient temperature (operation)/操作温度	-25°C~+85°C				
Contact resistance/接触电阻	≤5mΩ				
Insulation resistance/绝缘电阻	≥100MΩ				
Connector body/胶芯	TPU				
Male pin/公端子	Brass with gold plated/黄铜镀金				
Female pin/母端子	Phosphorus copper with gold plated/磷铜镀金				
Screw/螺丝	Brass with nickel plated/黄铜镀镍				
Environmental compliance/环境符合标准	RoHs, Reach				

M12 C code male to female straight molded cable, shielded/M12, C型公头直头对母头直头连接线, 带屏蔽

Illustration/尺寸

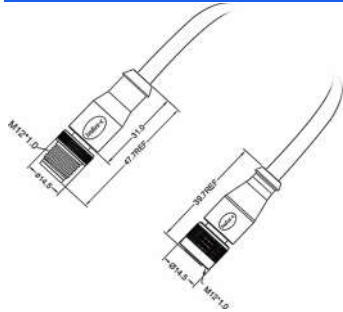

Product photo/产品图



Part number/产品料号

Pins/针数	Code/型	Part number("X" is length millimetre mm)/产品料号("X"表示长度, 单位毫米mm)		
		PVC jacket/PVC外被		PUR jacket/PUR外被
		-10°C~+80°C	-40°C~+105°C	-40°C~+105°C
2pins/2针	C code/C型	12L01225-X	12L01226-X	12L01227-X
3pins/3针	C code/C型	12L01255-X	12L01256-X	12L01257-X
4pins/4针	C code/C型	12L01285-X	12L01286-X	12L01287-X
5pins/5针	C code/C型	12L01315-X	12L01316-X	12L01317-X
6pins/6针	C code/C型	12L01345-X	12L01346-X	12L01347-X

Pin assignment front view/针位分布前视图

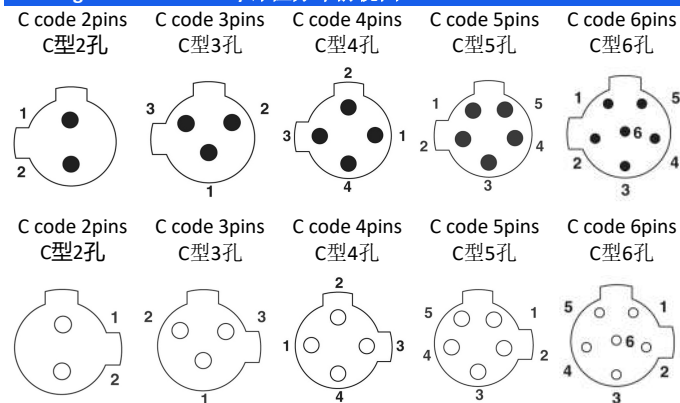

General data/常规数据

Pin Numbers/针数	2pins/2针	3pins/3针	4pins/4针	5pins/5针	6pins/6针
Rated voltage/额定电压	250V			60V	30V
Rated current(40°C)/额定电流	4A				2A
Standards/标准	IEC 61076-2-101				
Termination/焊接方式	solder/焊接				
Degree of protection/防护等级	IP67, IP68, IP69K				
Wire gauge(mm²)/线规(平方数)	0.14mm²-0.75mm²				
Wire gauge(AWG)/线号(平方数)	26AWG-18AWG				
Mechanical operation/插拔次数	>100 mating cycles/大于100次				
Ambient temperature (operation)/操作温度	-25°C~+85°C				
Contact resistance/接触电阻	≤5mΩ				
Insulation resistance/绝缘电阻	≥100MΩ				
Connector body/胶芯	TPU				
Male pin/公端子	Brass with gold plated/黄铜镀金				
Female pin/母端子	Phosphorus copper with gold plated/磷铜镀金				
Screw/螺丝	Brass with nickel plated/黄铜镀镍				
Environmental compliance/环境符合标准	RoHs, Reach				

M12 C code female to female right angle molded cable, shielded/M12, C型母头弯头对母头弯头连接线, 带屏蔽

Illustration/尺寸

Product photo/产品图

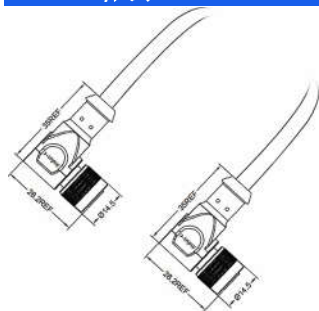

Part number/产品料号

Pins/针数	Code/型	Part number("X" is length millimetre mm)/产品料号("X"表示长度, 单位毫米mm)		
		PVC jacket/PVC外被		PUR jacket/PUR外被
		-10°C~+80°C	-40°C~+105°C	-40°C~+105°C
2pins/2针	C code/C型	12L01228-X	12L01229-X	12L01230-X
3pins/3针	C code/C型	12L01258-X	12L01259-X	12L01260-X
4pins/4针	C code/C型	12L01288-X	12L01289-X	12L01290-X
5pins/5针	C code/C型	12L01318-X	12L01319-X	12L01320-X
6pins/6针	C code/C型	12L01348-X	12L01349-X	12L01350-X

Pin assignment front view/针位分布前视图

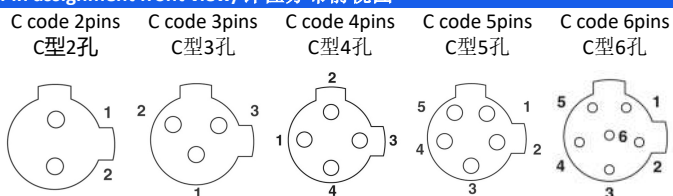

General data/常规数据

Pin Numbers/针数	2pins/2针	3pins/3针	4pins/4针	5pins/5针	6pins/6针
Rated voltage/额定电压	250V			60V	30V
Rated current(40°C)/额定电流	4A				2A
Standards/标准	IEC 61076-2-101				
Termination/焊接方式	solder/焊接				
Degree of protection/防护等级	IP67, IP68, IP69K				
Wire gauge(mm²)/线规(平方数)	0.14mm²-0.75mm²				
Wire gauge(AWG)/线号(平方数)	26AWG-18AWG				
Mechanical operation/插拔次数	>100 mating cycles/大于100次				
Ambient temperature (operation)/操作温度	-25°C~+85°C				
Contact resistance/接触电阻	≤5mΩ				
Insulation resistance/绝缘电阻	≥100MΩ				
Connector body/胶芯	TPU				
Pins/端子	Phosphorus copper with gold plated/磷铜镀金				
Screw/螺丝	Brass with nickel plated/黄铜镀镍				
Environmental compliance/环境符合标准	RoHS, Reach				

M12 C code female straight to female right angle molded cable, shielded/M12, C型母头直头对母头弯头连接线, 带屏蔽

Illustration/尺寸

Product photo/产品图

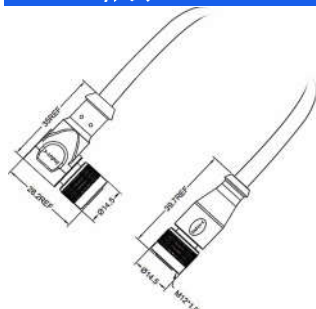

Part number/产品料号

Pins/针数	Code/型	Part number("X" is length millimetre mm)/产品料号("X"表示长度, 单位毫米mm)		
		PVC jacket/PVC外被	PUR jacket/PUR外被	
		-10°C~+80°C	-40°C~+105°C	-40°C~+105°C
2pins/2针	C code/C型	12L01231-X	12L01232-X	12L01233-X
3pins/3针	C code/C型	12L01261-X	12L01262-X	12L01263-X
4pins/4针	C code/C型	12L01291-X	12L01292-X	12L01293-X
5pins/5针	C code/C型	12L01321-X	12L01322-X	12L01323-X
6pins/6针	C code/C型	12L01351-X	12L01352-X	12L01353-X

Pin assignment front view/针位分布前视图

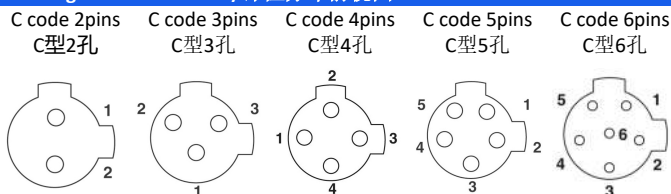

General data/常规数据

Pin Numbers/针数	2pins/2针	3pins/3针	4pins/4针	5pins/5针	6pins/6针
Rated voltage/额定电压	250V			60V	30V
Rated current(40°C)/额定电流	4A				2A
Standards/标准	IEC 61076-2-101				
Termination/焊接方式	solder/焊接				
Degree of protection/防护等级	IP67, IP68, IP69K				
Wire gauge(mm²)/线规(平方数)	0.14mm²-0.75mm²				
Wire gauge(AWG)/线号(平方数)	26AWG-18AWG				
Mechanical operation/插拔次数	>100 mating cycles/大于100次				
Ambient temperature (operation)/操作温度	-25°C~+85°C				
Contact resistance/接触电阻	≤5mΩ				
Insulation resistance/绝缘电阻	≥100MΩ				
Connector body/胶芯	TPU				
Pins/端子	Phosphorus copper with gold plated/磷铜镀金				
Screw/螺丝	Brass with nickel plated/黄铜镀镍				
Environmental compliance/环境符合标准	RoHS, Reach				

M12 C code female to female straight molded cable, shielded/M12, C型母头直头对母头直头连接线, 带屏蔽

Illustration/尺寸

Product photo/产品图

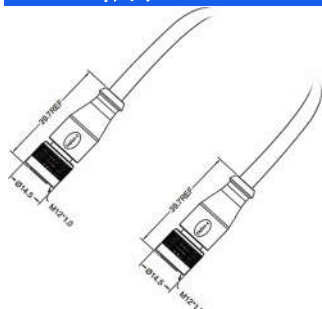

Part number/产品料号

Pins/针数	Code/型	Part number("X" is length millimetre mm)/产品料号("X"表示长度, 单位毫米mm)		
		PVC jacket/PVC外被		PUR jacket/PUR外被
		-10°C~+80°C	-40°C~+105°C	-40°C~+105°C
2pins/2针	C code/C型	12L01234-X	12L01235-X	12L01236-X
3pins/3针	C code/C型	12L01264-X	12L01265-X	12L01266-X
4pins/4针	C code/C型	12L01294-X	12L01295-X	12L01296-X
5pins/5针	C code/C型	12L01324-X	12L01325-X	12L01326-X
6pins/6针	C code/C型	12L01354-X	12L01355-X	12L01356-X

Pin assignment front view/针位分布前视图

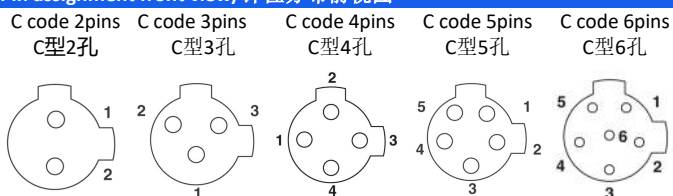

General data/常规数据

Pin Numbers/针数	2pins/2针	3pins/3针	4pins/4针	5pins/5针	6pins/6针
Rated voltage/额定电压	250V			60V	30V
Rated current(40°C)/额定电流	4A				2A
Standards/标准	IEC 61076-2-101				
Termination/焊接方式	solder/焊接				
Degree of protection/防护等级	IP67, IP68, IP69K				
Wire gauge(mm²)/线规(平方数)	0.14mm²-0.75mm²				
Wire gauge(AWG)/线号(平方数)	26AWG-18AWG				
Mechanical operation/插拔次数	>100 mating cycles/大于100次				
Ambient temperature (operation)/操作温度	-25°C~+85°C				
Contact resistance/接触电阻	≤5mΩ				
Insulation resistance/绝缘电阻	≥100MΩ				
Connector body/胶芯	TPU				
Pins/端子	Phosphorus copper with gold plated/磷铜镀金				
Screw/螺丝	Brass with nickel plated/黄铜镀镍				
Environmental compliance/环境符合标准	RoHS, Reach				